

# A Study on the Impact of Climate Adaptive Building Shells on Indoor Comfort

**Jacopo Gaspari<sup>1</sup>, Emanuele Naboni<sup>2</sup>, Caterina Ponzio<sup>3</sup>, Adele Ricci<sup>4</sup>**

1 School of Engineering and Architecture, Alma Mater Studiorum University of Bologna, Italy

2 The Royal Danish Academy of Fine Arts, Copenhagen, Denmark

3 IUAV, University of Venice, Italy

4 School of Engineering and Architecture, Alma Mater Studiorum University of Bologna, Italy, adele.ricci1@gmail.com

## **Abstract**

*Energy savings and indoor comfort are widely considered to be key priorities in the current architectural design trends. Additionally, the well-being and satisfaction of end users is a relevant issue when a human-centred perspective is adopted. The application of Climate Adaptive Building Shells (CABS) compared to conventional façades offers appropriate opportunities for tackling these challenges. This paper reports the outcomes of a study performed on CABS in order to optimise the indoor comfort while calibrating the configuration of a dynamic façade module. The horizontal louvres of the adaptive façade are moved by an actuator that exploits the expansion of a thermo-active resin as it melts, by its absorption of energy. The actuation mechanism depends on the outdoor air temperature conditions and does not require a supply of energy. The performed simulation evidenced a decrease of approximately 4°C indoors when the dynamic module is fully efficient (21<sup>st</sup> June at 12 p.m.). Furthermore, the lux level is always within the comfort range for an office building (500-2000 lux) during both winter and summer scenarios. The optimised solution shows a substantial gain for energy performance and environmental sustainability. Moreover, the uniformity of distribution of daylight illuminance across the entire space is another associated advantage, giving interesting insights into potentials for architectural façade design.*

## **Keywords**

*adaptive façade, parametric design, daylight, energy efficiency, building shells*

DOI 10.7480/jfde.2019.1.2778

## 1 INTRODUCTION AND OBJECTIVES

The building envelope usually represents the boundary between the indoor and outdoor environments, becoming a key and complex system to achieve optimal comfort and wellness standards for end users. This is certainly a relevant issue, considering that in today's society most people spend over 90% of their time inside buildings. The use of Climate Adaptive Building Shells allows for conditions to be improved to users' satisfaction, while simultaneously decreasing the need for equipment. However, most of these systems are still very complex and expensive, and they require supplied energy to operate. Intrinsically controlled systems applied to kinetic façades enable the merging of the sensor and the motion actuator into the same component, allowing for its kinetic elements to move without requiring supplied energy. The level of sustainability of CABS depends on the difference between energy supplied and energy saved. A large amount of energy is usually required to activate the actuators and sensors used in adaptive façade systems (Barozzi, Lienhard, Zanelli, & Monticelli, 2016). To make allowances for sustainability of the whole system, operational costs must also be carefully considered. A large amount of buildings still have louvres and shutters fixed outside windows; if manually activated these elements are low-energy and low-cost devices.

If these elements are re-designed in an innovative way, they allow for an adaptive environment without complex automatic systems. Potential perks of the reduction in operating energy supplied by the system should overcome the additional capital and carbon costs of the system itself. The high construction cost and technological complexity that characterise CABS are still unresolved in terms of their limits (Barozzi et al., 2016). Nowadays, CABS belongs to quite a restricted area of application and the aim of this study is to try to take a step towards widening the opportunities for their use. For this reason and for the reasons we have pointed out above, the façade's design was focused on reducing operational energy while trying to keep the technological complexity under control (Boake, 2014).

The study was driven by the idea of adopting a relatively conventional solution and re-designing it to adapt its potential advantages to a simple but effective adaptable façade system. Since the introduction of energy simulation software, the integration of parametric design and performance simulation allows designers to test the efficiency of a system. In this specific case, the use of energy simulation models has allowed the thermal and light conditions of the indoor environment to be monitored, and the testing of the efficiency of the façade as a whole. In conclusion, the aim of this work is to design a passive kinetic façade with intrinsic control and study its effects on indoor comfort through a replicable design method based on parametric design and simulation tools.

## 2 BACKGROUND AND METHODOLOGY

As recent literature shows, successful building performance simulation has been considered as 'the right type of virtual experiment with the right model and tool' (Godfried, 2011). For this reason, there is a great demand for tools and instruments that can be used in the design process of kinetic façades (Nielsen, Svendsen & Bjerreg, 2011; Shen & Tzempelikos, 2012). Accordingly, the work of Ayman and Yomna (2016) on parametric-based designs for kinetic façades applied to daylight performances, aims to provide a toolkit for daylight control inside buildings, combining different software programs such as Grasshopper and Diva. Similarly, the study of Loonen, Trčka, Cóstola, & Hensen (2010) explores the potential role that building performance simulation plays in designing CABS by taking the window technology Smart Energy Glass as a case study and coupling TRNSTS and DAYSIM to

build a model for performance simulations. From the beginning of the study, the focus was set on the need to keep both luminous and thermal aspects together, to obtain a tool that would consider the two major aspects that influence the indoor comfort. For this reason, the research targets a series of design problems: design integration through tool development, and design process improvement through the incorporation of physics-based modelling and real-world dynamics.

## 2.1 GENERAL DESIGN PROCESS

A method marked by parametric design, dynamic simulations, and in-situ measurements has been developed, in order to monitor the tool's validity. The method allowed for the evaluation of the effects of the façade on indoor comfort.

The study can be divided into three phases:

- design of the thermal and luminous simulation model;
- testing of the model: on-site physical measurements and comparison with the simulation model results; and
- testing of the façade.

Mean radiant temperature (°C) and illuminance levels (lux) were assumed as key parameters for the investigation.

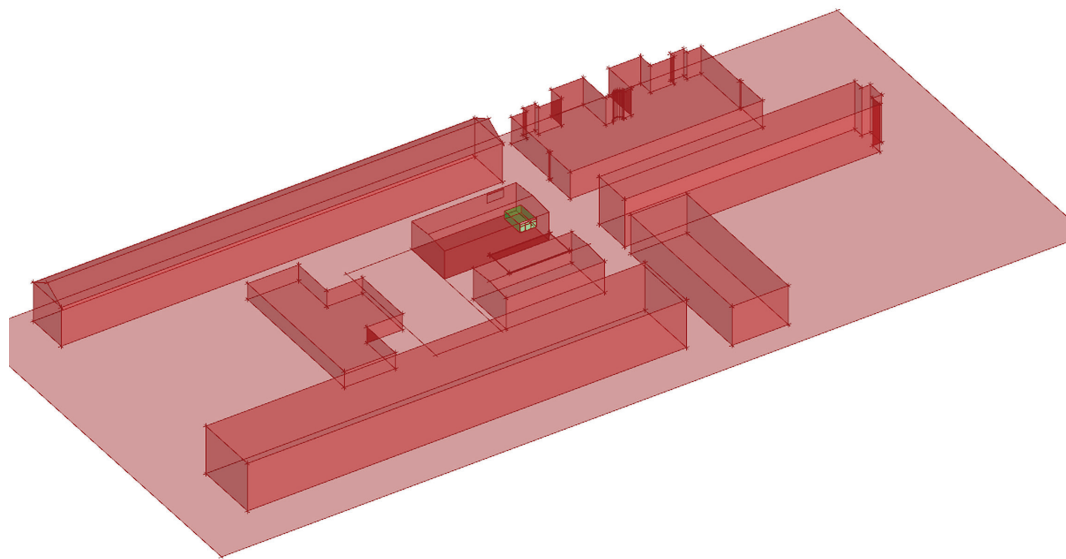

FIG. 1 Simulation model with all buildings modelled (red) and the thermic zone (green)

A simulation model to reproduce the real environment of measurement was set. Measured experiments were conducted in a full-scale test room designed as daylight laboratory at The Royal Academy of Fine Arts in Copenhagen (Denmark). Illuminance values were measured and simulated at two points: P1 located at 1.5 m and P2 at 5.5 m from the window. A luxometer was placed in P1 and P2 at a height of 0.8 m, like the height of a worktop, such as a desk or a small table. Mean radiant temperature (MRT) was measured and simulated at 1.5 m from the window as a main heat dispersion source on P2 at a height of 1.1 m, the centre of gravity of a man standing (Fig. 4).

The room was considered as a sealed environment, and measurement was done while keeping windows and doors closed so that no heating or cooling system would generate convective air movements. Air speed measurements carried out hourly on P1 and P2 with a hot-wire anemometer were always below 0.1 m / s (measuring tool technical specifications are outlined below in Section 2.4). We decided not to take into account electricity consumptions for this phase of the research. All luminous contributions are due to natural daylight as the electrical system was not switched on. The façade was designed as a set of horizontal louvres that shields the sun via a downwards-rotative movement. The façade is kinetic and intrinsically controlled as it is moved by a passive movement actuator, which turns the sun-blinds in response to the outside temperature. Façade technology will be explained in detail in Section 4. The geometry of the louvres was shaped using Grasshopper-Honeybee (McNeel Europe, n. d.) and embedded into the simulation workflow as a shading device. Honeybee is an environmental design plug-in for Grasshopper that connects Radiance and Energyplus, which we used for the simulation model design (Davidson, 2013). This model was used for comparing simulated data with measured data and to monitor the façade's effects on the indoor comfort of the mock-up.

## 2.2 MODEL DEFINITION AND SIMULATION

The simulation model's thermal and luminous behaviour must be similar to real conditions if it is to return values comparable with those which are measured. For this reason, the modelled room's dimensions are the same as the daylight laboratory. The room communicates with the outside through a completely glazed closing surface. The room was inserted into the campus building and only one wall was modelled as being exposed to the outdoors. It was modelled following its real dimensions, orientation, and thermal and luminous properties. The room is oriented to the east. Copenhagen EnergyPlus weather file (.EPW file extension) was downloaded on September 27, 2017 (U. S. Department of Energy, n. d.) and inserted in the model. The light room is considered as a thermal zone formed by the union of the various Honeybee surfaces, joined together by the 'Honeybee\_CreateHBZones' command. Each surface was set to have certain thermal and light properties. The thermal properties were determined through the assignment to the surface of a 'Honeybee\_EP Construction', while luminous ones were assigned using 'Honeybee\_RadianceOpaqueMaterial' (for opaque partitions) and 'Honeybee\_RadianceGlassMaterial' (for a window). A list of thermal and luminous parameters is included in the following tables.

The room was free of any cooling or heating systems and free from artificial lighting equipment. The thermal zone inside the simulation model was set as a sealed environment; measurements were made keeping doors and windows closed and there were no heating or cooling systems inside the test room that would generate convective movements. Since nobody was working inside the lab while the measurements were taken, the thermal load due to the occupants was considered null. Context buildings were added to the thermal simulation as 'Honeybee\_EPContextSurfaces', and reflectance values of surrounding materials were also settled (Table 3).

With 'Honeybee\_GenerateClimateBasedSky', a sky was created with radiation values calculated according to the weather file at a specific time of the year. Illuminance on points of the simulated space, P1 and P2 (which corresponded to P1 and P2 in the measured space) was calculated by connecting the 'Honeybee grid-based simulation' to the command running the Radiance simulation. According to Jakubiec and Reinhart (2011), the following input was inserted in the simulation model to achieve good accuracy for daylight modelling results.

ROOM'S COMPONENTS	TRANSMITTANCE (U-VALUE) [W/M2K]
Exterior wall	0.98
Exterior window	4.43
Interior floor, ceiling	1.44
Interior walls	2.58
Exterior roof	1.45

TABLE 1 Input parameters for thermal simulations

RADIANCE MATERIALS	REFLECTANCE VALUE
Ceiling	0.98
Interior walls	4.43
Floor	1.44
Shadings (Kinetic Façade)	2.58
TRANSMITTANCE VALUE	
Window	0.65

TABLE 2 Materials' properties used for Radiance daylight model

RADIANCE MATERIALS	REFLECTANCE VALUE
External ground	0.20
Aged asphalt	0.10
Buildings (brick cladding)	0.25

TABLE 3 Materials' properties used for Radiance daylight model

SIMULATION PARAMETER	VALUE
Ab – ambient bounces	5
Ad – ambient divisions	1024
As – ambient supersamples	16
Ar – ambient resolution	256
Aa – ambient accuracy	0.10

TABLE 4 Input parameters for thermal simulations

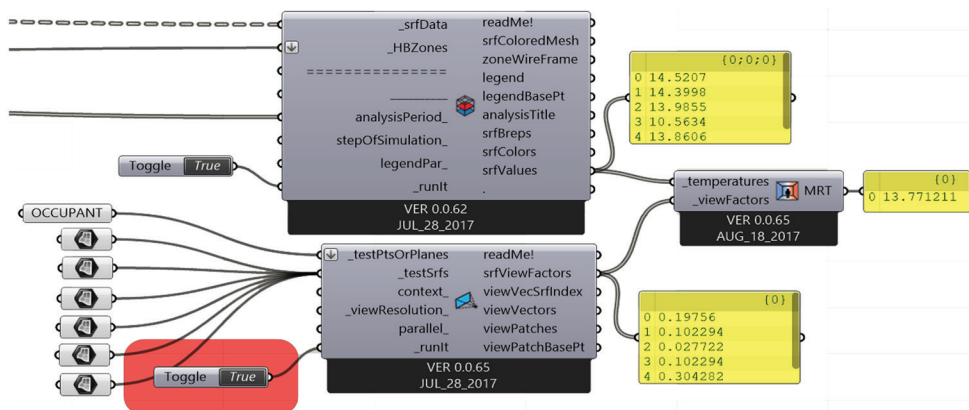

FIG. 2 Illustration of the parametric logic of the room's model within the Grasshopper Algorithm, MRT workflow calculation

With EnergyPlus simulation, the surface temperature of the test room's walls was evaluated. 'Ladybug\_MRTCalculator' then elaborated these temperatures. Therefore, MRT on P2 has been simulated by the software (Fig. 2).

The façade structure has been included in the model, and its effects on indoor comfort monitored through simulated values of illuminance and MRT. Previous set parameters have been considered constant during the façade's design process.

## 2.3 SIMULATION SCENARIO

To verify the effectiveness of the new façade design, three shells' configurations were simulated for two days of the year: December 21<sup>st</sup> and June 21<sup>st</sup> (Fig.3). The winter and summer solstices were chosen because they are accepted to be the worst and best days, respectively, in terms of air temperature and hours of daylight. Configurations are dependent on the external air temperature because the movement actuator moves according to the temperature (see Section 4).

- Configuration 0: No shells.
- Configuration 1: Sun-shutters inclined at 0°, horizontal position, when the air temperature is below 16 °C and motion actuators are at rest.
- Configuration 2: Sun-shutters inclined at 45° compared to Configuration 1, when the outside air temperature is higher than 24 °C.

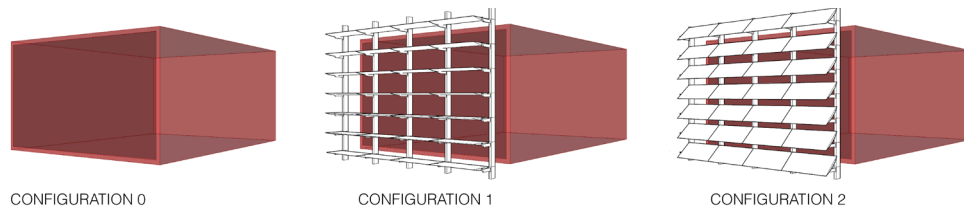

FIG. 3 3D model of the system configurations

## 2.4 TESTING THE MODEL

In-situ measured parameters were compared with the results of energy simulations. Measured experiments were conducted in November 2017 in a full-scale test room (Fig. 4) designed as a daylight laboratory. The room is inside the KADK campus, consisting of several buildings connected by open spaces belonging to the university. As Fig. 4 shows, the room is a rectangular space with a fully glazed wall, facing southeast.

The objective of this testing phase was to understand and monitor the thermal and luminous conditions of the room, air temperature, and relative humidity, MRT, illuminance, and solar radiation. To collect an adequate amount of climatic data, three climatic stations were placed inside the room, and a further one was placed outside. As Fig. 4 and Fig. 5 explain, the two indoor points were located at 1.1 m and 0.8 m above floor level and 2.7 m from side walls. P1 and P2 were positioned at 5.5 m and 1.5 m, respectively, from the window (Fig.5). The outdoor measurement station (P3) was instead fixed on the railing, 1.1 m above the floor level, on the same virtual line of P1 and P2.

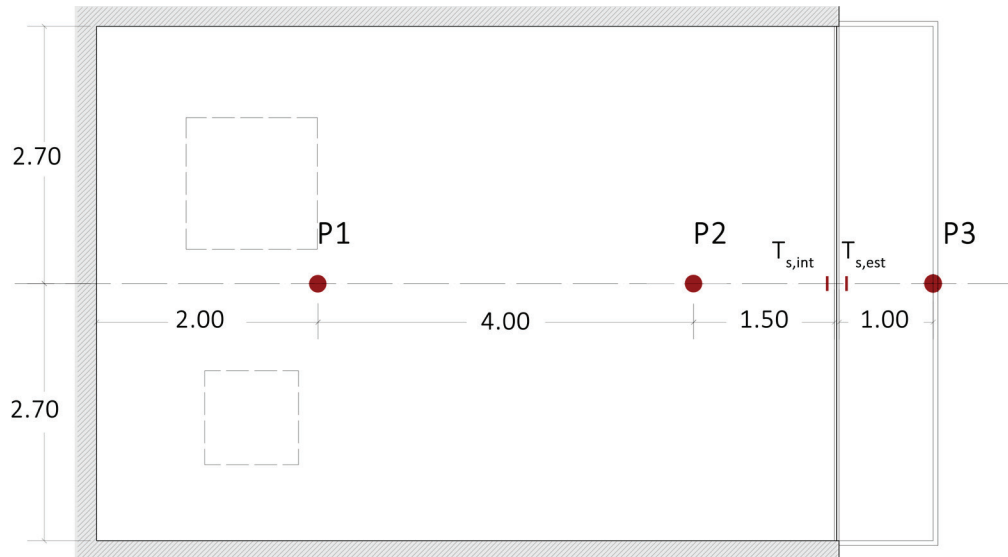

FIG. 4 Floor plan of the room with points of measurements (red dots – P1, P2, P3) and sensors for the surface temperature of the glass (red lines)



FIG. 5 Overview of the stations in the test room (P2 indoor and P3 outdoor) during the measurement phase

During this first phase, the following tools were used:

- Hobo U12-012 (data logger and sensors) for illuminance (lux), air temperature (°C) and relative humidity (%) range -20 to 70 °C, 0 to 35000 lux, 5 to 95%, accuracy  $\pm 0.35^{\circ}\text{C}$ ,  $\pm 2.5\%$ ,
- KIMO Black Ball + data logger for mean radiant temperature (°C), range 0 to 60 °C, accuracy  $\pm 0.5^{\circ}\text{C}$ ;
- S-LIB M003 Pyranometer + data logger for solar radiation (W/m<sup>2</sup>), range 0 to 1280 W/m<sup>2</sup>, accuracy  $\pm 10$  W/m<sup>2</sup>;
- Onset M-TMB-M006 sensor for air temperature (°C), range -40 to 100 °C, accuracy  $\pm 0.2^{\circ}\text{C}$ ;
- Rs Pro 1340 hotwire anemometer (m/s), range 0.1 to 30 m/s, accuracy  $\pm 0.02$  m/s.

The minimum standard of instruments and measurement methods followed the UNI EN ISO 7726, 'Ergonomics of the thermal environment - Instruments for measuring physical quantities' (UNI EN, 2002). All data collected during the measurement phase was grouped and categorised in Excel files. Afterwards, the indices describing the factors of comfort in the room (such as air temperature in °C, humidity in %, and illuminance in lux) were extracted from the equation and added to the weather file used in the workflow to calibrate the 3D simulation model. Among the collected data measurements, those of two specific days - the sunniest day and the rainiest day - were then

isolated. As per the above description (Section 3.2), the simulation was set up to be as similar as possible to the real conditions in the room, featuring the same thermic and luminous characteristics; here, the measured MRT data is compared to the simulated MRT data (Fig. 6).

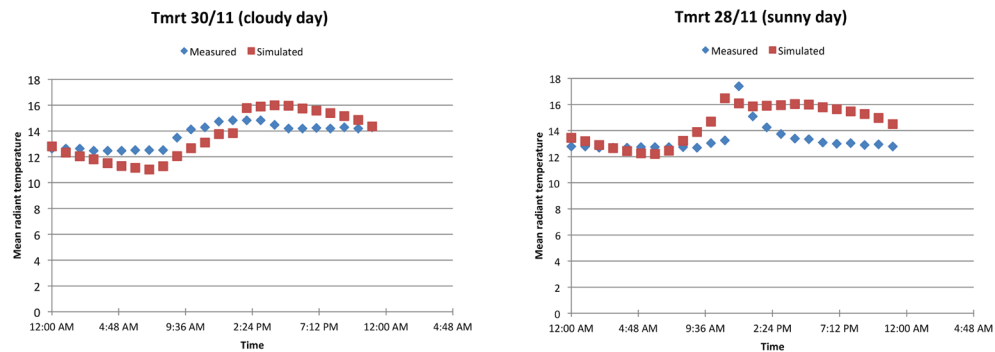

FIG. 6 Comparison between measured and simulated data of the MRT in the room during cloudy day (left) and sunny day (right)

### 3 ADOPTED FAÇADE TECHNOLOGY

In this section, façade kinetic movements and technology will be examined further. As previously reported, the façade was made using horizontal louvres that shield the sun through an adaptive and intrinsically controlled rotating movement. The geometry of the louvres was shaped using Grasshopper-Honeybee and embedded into the simulation workflow, and its technological aspects were also studied.

In order to shield solar radiation before it impacts on the glass surface and generates an increasing heat load, a façade system has been installed outside the glass surface. The designed solution involves the installation of horizontal louvres of 500 mm depth, with a gap of 500 mm between each one. These horizontal louvres rotate around a pivot and reduce the light permeable surface. To increase the sustainability of the system, a façade moved by a passive control system that could increase thermal and lighting comfort without energy consumption has been assumed as a main objective. Thus, elements of climate adaptive building shell are moved by a thermal actuator that exploits the expansion of a thermo-active resin that melts by absorbing thermal energy (solar radiation). This provides a mechanism that is responsive to passive energy exchanges given by meteorological conditions. A passive movement actuator makes possible the kinetic adaptability. The sun shading subsystem is supported by steel pillars that connect it with the building's structure (Fig.8).



## 3.1 FAÇADE TECHNOLOGY

### Louvres

Horizontals louvres are made from perforated aluminium sheets of dimensions 1200x500mm. They are fixed to the structural steel bracket with bolts and hooked to a pivot that allows rotation (Fig.7). Despite its high-embodied energy, aluminium has been selected for its low weight and high durability for installation in the external environment. The actuator is situated under the shading device because it needs to be sheltered from direct radiation heat gain. A perforated sheet is used to let the air flow for natural ventilation purposes.

### Movement actuator

The actuator - designed by an English company (Bayliss Autovents, n. d.) - is usually used for the automatic greenhouse ventilation. It's made up of a hollow aluminium cylinder filled with density-change paraffin. The paraffin increases in volume in relation to the external temperature and allows a piston to move with a straight movement along its longitudinal axis. Furthermore, the rectilinear movement is transformed into a rotational movement by an aluminium support and a hinged joint that is able to rotate and close louvres. The actuator selected for the façade has an operating temperature range between 15 °C (temperature at which the wax starts to melt) and 35 °C (complete melting of the wax). At 35°C, the opening angle reaches 54° of rotation. The pushing force of the resin can bear a weight up to 6 kg (Fig.7).

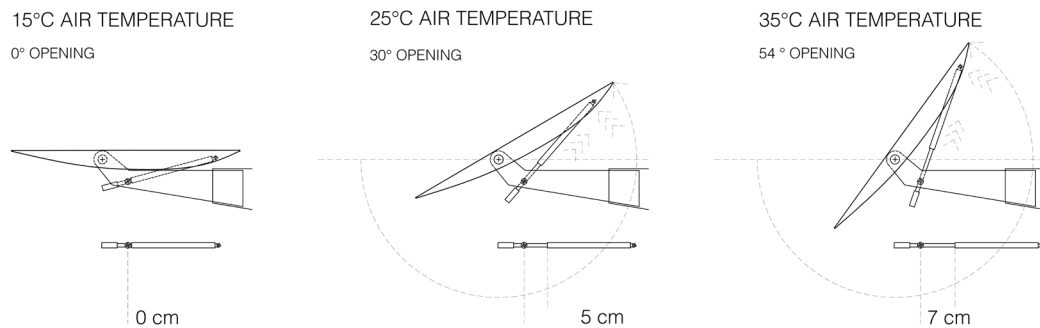

FIG. 7 Mechanical system for implementing the movement of the façade

### Structural grid

The sun-blinds are anchored to the building's external walls by a frame made of profiled aluminium. A metal deck acts as a horizontal stiffener, as well as an inspection space for maintenance purposes. Thanks to this system, the ordinary maintenance of each module is allowed without the use of external platforms. Embodied energy issues relating to CABS can be reduced by designing durable and easily maintained components (Boake, 2014).

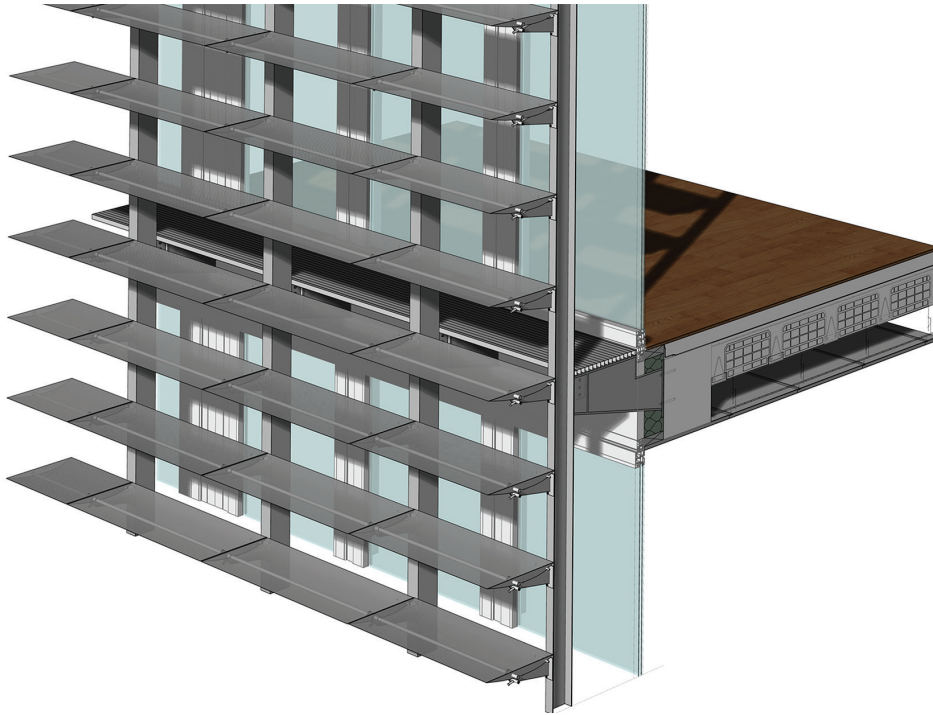

FIG. 8 3D model of façade

## 4 RESULTS

The outcomes of this testing phase are presented in the following section with the related results of MRT values (°C) in Table 5 and illuminance levels (lux) in Table 6.

### 4.1 RESULTS OF SIMULATION SCENARIO

#### Mean radiant temperature (°C)

In Table 5, each configuration's (Fig.3) MRT values at point P2 are presented. The new façade design shows that, in winter-time, the façade stays at Configuration 1 and allows for a slight increase in temperature in the morning (about 0.4 °C), compared to the 'no shells' configuration (Configuration 0), while it's null at noon. Additionally, Configuration 2 isn't obtained because the external temperature of 24°C is not reached. In summer-time, Configuration 2 is obtained. The façade allows the temperature to decrease by 4°C compared to the static configuration (Configuration 1), both at 09.00 a.m. and at noon.

DAY	HOUR	CONFIGURATION 0	CONFIGURATION 1: 0°	CONFIGURATION 2: 45°
21 Dec	9:00	11.4	11.8	-
	12:00	13.8	13.8	-
21 Jun	9:00	32.9	27.0	23.1
	12:00	35.1	28.2	24.3

TABLE 5 Analysis of MRT [°C] values on the measure point P2

### Illuminance(lux)

In Table 6, each configuration's (Fig. 3) illuminance values at points P1-P2 are presented. The new façade design shows that in winter-time (Configuration 1), the façade allows values to be obtained that are always higher than 200 lux. As Keller and Rutz (2010) typify in their guidelines for illuminance according to visual task, this threshold is characterised by a 'large visual task, large details, strong contrast. Moreover, in Denmark on 21<sup>st</sup> December at 09.00 a.m., very low incoming solar radiation is recorded; Configuration 1 doesn't preclude the passage of light.

During summer time, 45° rotated louvres are necessary to lower the level of illuminance below 1500 lux, a threshold characterised by "very difficult visual task, very small details, very low contrast" (Keller & Rutz, 2010).

MRT and illuminance values decrease during summer-time, while solar radiation reaches the core of the room in winter-time. Adaptability allows a substantial gain for thermal performance and therefore increases the system's sustainability.

DAY	HOUR	CONFIGURATION 0	CONFIGURATION 1: 0°	CONFIGURATION 2: 45°
21 Dec	9:00	P1 =3.51 P2 =17.35	P1 =2.56 P2 =8.27	- -
	12:00	P1 =330.4 P2 =1339.9	P1 =257.5 P2 =798.4	- -
21 Jun	9:00	P1 =1744.4 P2 =7462.0	P1 =1145.9 P2 =4044.3	P1 =320.4 P2 =1375.5
	12:00	P1 =1140.9 P2 =5778.8	P1 =856.5 P2 =2879.9	P1 =291.8 P2 =1212.8

TABLE 6 Analysis of illuminance level [lux] on the measuring point P1 and P2

## 4.2 CASE STUDY APPLICATION

In order to prove the method's replicability, the workflow explained above has been applied to a master's dissertation project within the Sustainable Built Environment graduation laboratory submitted at the School of Engineering and Architecture of Alma Mater Studiorum University of Bologna, on March 22, 2018. The dissertation was concerned with a hostel design located in the city of Bologna, Italy. This city is located in the climatic zone ASHRAE 4A and differs from Copenhagen since it tends to be a warmer climate, especially in summer. This allows us to understand façade behaviours in a different climatic zone from that of Denmark.

Façade technology has been used as shading device on one of the hostel's guest rooms. The room, smaller than the daylight laboratory in Copenhagen, was modelled in the Rhino software and replaced as a new thermal zone. It has an area of 14 m<sup>2</sup> and a floor to ceiling height of 2.90 m. The external façade to which the adaptive system has been applied, is oriented to the south and has a large glazed surface. The building's construction is made up of a hollow-core concrete structure, similar to that of the test box.

The two measurement points are located in the middle of the room ( with respect to the side walls); P2 is located at 1 m from the opening and P1 is located at 2.5 m from P2. Similarly to the test box in Copenhagen, illuminance values were measured at P1 and P2 at a height of 0.8 m from the floor, and MRT values were measured at P2 at 1.1 m.

DAY	HOUR	CONFIGURATION 0	CONFIGURATION 1: 0°	CONFIGURATION 2: 45°
21 Dec	9:00	9.35	9.2	-
	12:00	13.9	13.6	-
21 Jun	9:00	36.4	34.1	33.7
	12:00	41.0	37.9	37.0

TABLE 7 Analysis of MRT values [°C] on the measure point P2

DAY	HOUR	CONFIGURATION 0	CONFIGURATION 1: 0°	CONFIGURATION 2: 45°
21 Dec	9:00	P1= 537.64 P2=1150.3	P1= 443.9 P2=967.8	- -
	12:00	P1= 8998.9 P2=10642.8	P1= 8074.0 P2= 8461.0	- -
21 Jun	9:00	P1= 1425.5 P2= 3690.2	P1= 1076.2 P2= 1927.3	P1=476.8 P2=999.35
	12:00	P1= 2647.1 P2= 7145.0	P1= 1978.3 P2=4147.2	P1= 822.3 P2=1636.8

TABLE 8 Analysis of illuminance level [lux] on the measuring point P1 and P2

As shown in Table 7 and Table 8, results clearly indicate that the façade is effectively efficient with regard to the mitigation of the lux level, while the MRT variation is limited.

## 5 CONCLUSIONS AND FURTHER DEVELOPMENT

The method explained throughout allows the monitoring of light and temperature within buildings whose parameters are indeed essential to controlling the indoor comfort of the structure, using a completely passive technological adaptive system (David, Donn, Garde, & Lenoir, 2004).

This paper aims to prove that through science and design computation, as well as an empirical research method, design teams are enabled to improve the process involved in managing the simulation and evaluation of daylight and temperature performances over the course of the design process itself.

Some remarks on the results:

- the creation of models has been acknowledged as a useful tool in verifying the design choices relative to the CABS if accompanied by accurate monitoring of the same, as well as data validation;
- CABS have been proven to be an effective choice to improve MRT as well as to balance the illuminance level.

The study leaves room for future developments to be built on its findings, as well as expanded upon exploration of a set of optimisation criteria, which should combine the energy-related indicators with the visual comfort ones, such as glare probability, daylight and illuminance uniformity, and factors of external view.

## References

- Ayman, H. A. M., & Yomna, E. (2016). Parametric-based designs for kinetic façades to optimize daylight performance: Comparing rotation and translation kinetic motion for hexagonal façade patterns. *Solar Energy*, vol. 126, pp. 111-127.
- Barozzi, M., Lienhard, J., Zanelli, A., & Monticelli, C. (2016). of the sustainability of adaptive envelopes: developments of kinetic architecture. *Procedia Engineering*, vol. 155, pp. 275-284.
- Bayliss Autovents (n. d.), retrieved September 2017 from [www.baylissautovents.co.uk](http://www.baylissautovents.co.uk).
- Bluyssen, P.M., Aries, M., & Van Dommelen, P. (2011). Comfort of workers in office buildings: the European HOPE project. *Building Environment*, vol. 46, pp. 280-288.
- Boake, T.M., (2014). Hot climate double façade: avoiding solar gain. *Façades Tectonic*, vol. 14 , pp. 2-24.
- Boerstra, A.C., Beuker, T., Loomans, M.G.L.C., & Hensen, J.L.M. (2013). Impact of available and perceived control on comfort and health in European offices. *Architectural Science Review*, vol. 56, issue 2.
- Cole, R.J., & Brown, Z. (2009). Reconciling human and automated intelligence in the provision of occupant comfort. *Intelligent Buildings International*, vol.1.
- David, M., Donn, M., Garde, F., & Lenoir, A.(2004). Assessment of the thermal and visual efficiency of solar shades. *Building Environment*, vol. 46, pp. 1489-1496.
- Davidson, S. (2013). Grasshopper: Algorithmic Modelling for Rhino, NING/MODE, Brisbane, CA, USA. Retrieved from [www.grasshopper3d.com](http://www.grasshopper3d.com).
- Galasiu, A.D. & Veitch, J.A. (2006). Occupant preferences and satisfaction with the luminous environment and control systems in daylight offices: a literature review. *Energy and Buildings*, vol. 38, pp.728-742.
- Godfried, A., (2011). The role of simulation in performance based building. *Building Performance Simulation for Design and Operation*. Abingdon: Spon Press.
- Jakubiec J. A., & Reinhart C.F.(2011, November). Diva 2.0: Integrating daylight and thermal simulations using Rhinoceros 3D, Daysim, and EnergyPlus, *Proceedings of building simulations: 12<sup>th</sup> Conference of International Building Performance Simulation Association*, Sydney, 14-16 November.
- Keller, B., & Rutz S. (2010). *Pinpoint: Key Facts + Figures for Sustainable Buildings*. Basel:Birkhäuser.
- Leung, C. (2014). *Passive seasonally responsive thermal actuators for dynamic building envelopes*, (Doctoral dissertation). Retrieved from The Bartlett School of Architecture University College London Database, London.
- Loonen, R. (2010). *Climate Adaptive Building Shells. What can we simulate?* (Master's thesis) University of Technology, Eindhoven.
- Loonen, R.C.G.M., Trčka, M., Cóstola D., & Hensen J.L.M., (2010). Performance simulation of Climate Adaptive Building Shells - Smart Energy Glass as a case study, *Proceedings of the 8<sup>th</sup> International conference on System Simulation in Buildings*, pp. 1-19.
- McNeel Europe (n. d.) , Food for Rhino, retrieved October, 2017 from [www.food4rhino.com/app/ladybug-tools](http://www.food4rhino.com/app/ladybug-tools).
- Nielsen, M.V., Svendsen S., & Bjerreg, L., (2011). Quantifying the potential of automated dynamic solar shading in office buildings through integrated simulations of energy and daylight. *Solar Energy*, vol 85, pp. 757-768.
- Paciuk, M. (1989). *The role of personal control of the environment in thermal comfort and satisfaction at the workplace*.(Doctoral Dissertation). University of Wisconsin, Milwaukee.
- Schumacher, M., Schaeffer, O, Vogt, M., (2010). *Move: Architecture in Motion - Dynamic Components and Elements*, Basel: Birkhäuser.
- Shen H., & Tzempelikos, A., (2012). Daylighting and energy analysis of private offices with automated interior roller shades. *Solar Energy*, vol. 86, pp. 681-704.
- UNI EN ISO 7726, (2002). *Ergonomics of the thermal environment - Instruments for measuring physical quantities*.
- U.S. Department of Energy (n. d.), retrieved September 27, 2017 from [www.energyplus.net/weatherlocation/europe\\_wmo\\_region\\_6/DNK//DNK\\_Copenhagen.061800\\_IWEC](http://www.energyplus.net/weatherlocation/europe_wmo_region_6/DNK//DNK_Copenhagen.061800_IWEC).

