

Development of a Device for Measuring Parameters of the Sea Wave

Ahmed M. Alqataa, Eskender A. Bekirov., and Ennan R. Murtazaev

Abstract— In this work we study the developed measuring instrument of parameters of sea waves. The given theoretical studies of wave parameters determines wave speed, height, period and frequency in a digital form. The measured parameters from the microcontroller are transmitted through system GSM/GPRS - RS485/232 to the base station.

Index Terms— wave parameters, microcontroller, encoder, infra-red sensor, signal transmission.

I INTRODUCTION

The Black Sea is a closed sea; the tides are so small that they are almost invisible. The magnitude of the tidal fluctuations of the Black Sea level is from 3 to 10 cm [1]. In the open sea, winter waves reach a height of 6-7 m. The Black Sea shock waves reach a meter height.

Currents in the Black Sea at the coast of the Crimea are predominantly counterclockwise. The currents are weak, their speed rarely exceeds 0.5 m/s. Their main causes are river runoff and wind exposure. The greatest heights observed in the Black Sea were 14 m, the length of such waves was 200 m, on the approaches to the coast the maximum wave height was 6 m, the length – 120 m [1].

Wind speed and length of its acceleration in the sea have a great influence; waves up to 3 m high usually prevail. In open waters, maximum wave heights reach more than 10 m, and during strong storms they may exceed this level.

Seasonal fluctuations have a great influence on the sea level. In May-July, a high rise in the level of sea water is observed, in October-November a decrease in the level of sea water is observed. The level between winter and summer sea position is 40 cm.

The most often fluctuations of the level of the Black Sea are wind-driven. Their formation depends on certain atmospheric processes within the natural synoptic period; their duration ranges from 4 to 8 days. The averaged wave oscillation value for the Black Sea is 0.8 m. The theory of the onset of wave flow was developed by Academician V.V. Shuleikin [2] in 1954.

The Black Sea wave climate is assessed in [3] using a total of 38 years of data (1979–2016). As a first step, the long-term variations of the main wave parameters were evaluated using data provided by the European Center for Medium-

Range Weather Forecasts (ECMWF). Based on these values, the nearshore and offshore conditions from the Black Sea were evaluated. As to the satellite measurements, there is no correlation between the water depth and the wave resources, with more consistent values being reported in the western part of the basin. Regarding the spatial distribution of the extreme events, it seems that the storm conditions occurring in the western part are more consistent, while in the eastern sector it is more likely to encounter storm conditions reported for a relatively short time window. Based on these results, we can conclude that the Black Sea is a dynamic environment where the wave energy budget changes on a seasonal or inter-annual scale. These variations bring opportunities but also challenges, such as beach erosion due to wave action. Nevertheless, for navigation and offshore activities, more important are the occurrences of rough events, which influence in a negative way the safety and productivity of these sectors [3].

The paper [4] shows the results of a hindcast study of wind waves on the Black Sea based on a continuous numerical calculation for the period between 1949 and 2010. The large time span of this period makes it possible to obtain reliable statistical and extreme parameters of wind waves, as well as to assess the evolution of the Black Sea's wave climate. During this research average and extreme parameters of wind waves on the Black Sea were derived, which generally match with most recently published results. Additionally, an assessment of interannual and seasonal variability of storms on the Black Sea was carried out. A slight negative trend of both annual duration and quantity of storms was observed.

The present state of the Black Sea wave power was estimated in [5] based on the period 2012–2015, using wind data from the limited area atmospheric model ALADIN. It was found that the mean annual wave energy flux reach 4.8

kW/m for the South Western Black Sea and above 4 kW/m for the western shelf. 110 years wave hindcast was performed to evaluate the changes in the wave power and it was found that the wave power increased during the first half of the XX century for the western part of the sea (where it is highest) and decreased after the seventies. The study of the influence of the teleconnections showed that the changes in the wave power at the western shelf are driven by other factors (mainly linked with NAO and EA/WR) than the northern and eastern part of the sea, where it is linked with AMO and PDO and highest when they are both negative. As for the applicability of the wave energy as a renewable energy resource the conclusions taking into account the negative trend and climate projections are hardly optimistic and it may have some applications only in a combined wind-wave energy converters.

One of the urgent tasks of modern hydropower is the use of the energy of sea waves in order to convert wave energy into electrical energy. To solve this problem, it is necessary to have the technical parameters of the wave. Since the waves are not systematic and varying in predetermined values, it is necessary to analyze the disturbing effects that create the waves. Waves can be longitudinal and transversal. In longitudinal waves, particles of water oscillate along the distribution of the wave. Perpendicular oscillations of water particles to the direction of wave propagation create transversal waves. Wave movements include longitudinal and transversal oscillations, gravitational motions arising on the water surface in a circular motion, decrease with depth.

To determine the energy transferred by a wave that is characterized by Poynting vector or a vector of energy flux density, it is necessary to know the magnitudes, lengths and speeds of the wave.

II THEORETICAL STUDIES

Like any oscillation, waves can be represented as a superposition of harmonic waves, varying according to sinusoidal law with different parameters. The equation of one-dimensional harmonic waves :

$$\varphi(x, t) = A \sin \left[2\pi \left(\frac{1}{T} - \frac{x}{\lambda} \right) + \varphi \right] \quad (1)$$

Or

$$\varphi(x, t) = A \sin(\omega t - kx + \varphi) \quad (2)$$

where $k = 2\pi/\lambda$, – wave number (the number of waves, reducing)

A in this case is oscillation amplitude;

T – wave period, $T = \frac{2\pi}{\omega} = \frac{1}{\nu}$;

ω – cyclic frequency;

ν – linear frequency of oscillation of a particle in a wave;

λ – the length of a wave;

φ – particle deviation from positions in a wave.

In the wave motion in an elastic medium, there is no matter transfer. In the fluctuation of the sea waves, there is a transfer of matter. Depending on the direction of oscillation of particles of the medium (water) in a wave, the waves are longitudinal and transversal. In longitudinal waves, particles oscillate along the wave propagation. In transversal waves, the oscillation of the particles is perpendicular to the direction of the wave. In gravitational waves which contain components of both longitudinal and transversal oscillations, appearing, for example, on the surface of the water, particles make vertical movements along a circle with a radius decreasing with depth.

The source of the waves, acting on the volumes adjacent to it, continuously transfers energy to them which moves the wave in the water environment.

When the longitudinal wave propagates, which is characterized by equation (2), it is possible to determine the change in the energy of the volume dV . As the volume dV , let us choose an elementary cylinder (Fig. 1). The wave of the weight P and the radius r is driven by the force of the wave $F1$ and the force of the wind $F2$.

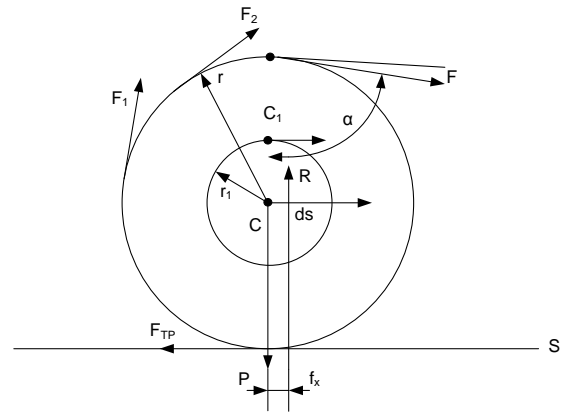

Figure 1 Cylinder

R – is the normal reaction force of the water plane shifted relatively to the center of inertia C of the wave by the magnitude of the rolling friction coefficient f_k in the direction of motion.

F – reaction force of the wave crest is equal in magnitude to the force applied to the wave.

F_{tp} – friction force of the wave on the horizontal plane of the water surface.

In accordance with the direction of the S axis, we shall take the positive direction of the angle of wave decrease α .

Let us write the theorem on the change in the kinetic energy of a system of material points when a wave moves un-

der the action of the force F and the speed of the center of inertia C of the wave at the moment it moves to the distance dS :

$$T_2 - T_1 = \sum_{k=1}^n A(F_k^l) + \sum_{k=1}^n A(F_k^i) \quad (3)$$

Since the wave is an immutable material system, the sum of the work of internal forces is zero, therefore

$$T_2 - T_1 = \sum_{k=1}^n A(F_k^l) \quad (4)$$

If the center of inertia C of the wave moves under the action of the force of the wave and the force of the wind on the elementary displacement dS directed along the S axis to the right, taking into account

the position of the instantaneous center of speeds φ we shall let :

$$dS = r d\varphi \quad (5)$$

where $d\varphi$ is elementary angular displacement of the wave around an instantaneous center of speeds Φ .

The elementary angular displacement of the wave $d\varphi$ is associated with the elementary displacement dS of the center of gravity C with the dependence.

The work of external forces on the elementary displacement dS is

$$\delta A = \delta A(P) + \delta A_{T.K.} + \delta A(F) + \delta A(F_{T.p.}) \quad (6)$$

Since the movement of the center of inertia C occurs horizontally, then

$$\delta A(P) = 0 \quad (7)$$

Elementary work of rolling friction

$$\delta A_{T.K.} = -m_{T.K.} d\varphi \quad (8)$$

The work of the rolling friction pair is negative, since the direction of the moment of the pair is opposite to the direction of the wave motion.

Since

$$m_{T.K.} = N \cdot f_k = (P - F \sin \alpha) f_k \quad (9)$$

then taking into account the formula (5), we shall find that

$$\delta A_{T.K.} = -(P - F \sin \alpha) f_k \frac{dS}{r} \quad (10)$$

The friction force Fmp does not work (when rolling without sliding $\mathcal{V}_\phi=0$).

$$\delta A(F_{T.p.}) = F_{Tp} \cdot \mathcal{V}_\phi \cdot dt = 0 \quad (11)$$

Let us calculate the elementary work of the force F . Let us choose point C as the pole, then

$$\delta A(F) = F \cdot dS + m_c d\varphi, \quad (12)$$

Where dS – is the vector of the elementary displacement of the center of inertia C ;

m_c – is a moment of force F relative to the axis passing through point C

perpendicular to the fixed plane, i.e. $m_c = F \cdot r_1$.

Then

$$\delta A(F) = F dS \cdot \cos \alpha + F \cdot r_1 d\varphi \quad (13)$$

using the formula (5), we shall have

$$\delta A(F) = \frac{F}{r} (r_1 + r \cos \alpha) dS \quad (14)$$

After substituting formulas (7), (10), (11), (14) into (2), we shall have the elementary work of external forces applied to the wave on the elementary displacement dS .

$$\delta A = \left[F(r_1 + r \cos \alpha) - f_k(P - F \sin \alpha) \frac{dS}{r} \right] \quad (15)$$

To determine the amount of work of external forces on the displacement of the center of inertia S , we shall, using formula (15), take a certain integral in the range from 0 to ∞ , as a result we shall get:

$$\sum A(F_k^l) = [F(r_1 + r \cos \alpha) - f_k(P - F \sin \alpha)] \frac{S}{r} \quad (16)$$

Let us calculate the kinetic energy of the waves that is in the initial position the wave was at rest, that is

$$T_1 = 0 \quad (17)$$

The kinetic energy in the final position of the wave is

$$T_2 = \frac{1}{2} M \mathcal{V}_e^2 + \frac{1}{2} I_c \omega^2 \quad (18)$$

Where $M = \frac{P}{g}$ – is the wave mass,

$I_c = \frac{P}{g} \rho^2$ – is the moment of inertia,

ρ – is the radius of inertia,

$\omega = \frac{\mathcal{V}_c}{r}$ – is the angular speed.

Therefore,

$$T_2 = \frac{1}{2} \frac{P}{g} \cdot \mathcal{V}_c^2 \left(1 + \frac{\rho^2}{r^2} \right) \quad (19)$$

Substituting (16), (17), (19) into equation (4) and solving this equation relatively \mathcal{V}_c , we shall find the desired speed of the center of wave C

$$\mathcal{V}_c = \sqrt{\frac{2grS}{r^2 + \rho^2} [F(r_1 + r \cos \alpha) - (P - F \sin \alpha)f_k]} \quad (20)$$

It can be seen from formula (20) that the wave is in motion if the modulus of force F satisfies the condition

$$F > \frac{P f_k}{r_1 + r \cdot \cos \alpha + f_k \cdot \sin \alpha} \quad (21)$$

The sliding friction f_k of a fluid has the viscosity value η which depends on the temperature t_0 of the water. The viscosity of water is 1 at 20° C.

Development of a device for measuring the parameters of the sea wave.

Various devices have been developed for measuring the wave energy [6-18], which do not allow obtaining the required data promptly; the accuracy of these devices is low, they have complex circuit solutions, the complexity of signal processing and design.

In order to improve the accuracy of measurement, constant monitoring of wave parameters, storage and transmission of information about speed, height and wavelength over a distance, an electronic device has been developed for measuring the parameters of the sea wave which can be used both in the coastal zone and at a considerable distance from the coastal strip.

The developed device (Figure 2) for measuring the parameters of the wave contains: №1

- Unit for measuring the speed of the wave;
- Infrared sensor;
- Ultrasonic sensor;
- Wavelength calculator;
- Decoder;
- Control panel;
- Microcontroller;
- Frequency generator;
- Liquid crystal indicator;
- Unit for reception and transmission of data

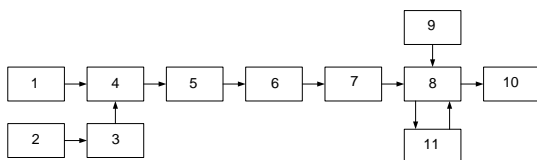

Figure 2. Block diagram of the device for measuring the parameters of the sea wave

The device for measuring the parameters of the sea wave consists of a unit for measuring the speed of the wave; ultrasonic sensor; unit measuring the height of the wave; infrared sensor; encoder; decoder; control panel; microcontroller; frequency generator; inductor; unit for reception and transmission of data.

Technical result will be: increased accuracy of measurement of parameters due to simplification of the design and use of modern electronic components and a microcontroller.

The task is solved due to the fact that the device for measuring parameters of sea waves contains of units for measuring the speed and height of the wave, the unit for receiving and transmitting these parameters of the waves which includes an ultrasonic sensor for measuring the level of wave height which is connected with its output via an encoder with the input of the microcontroller, as well as an infrared radiation sensor the signal from which is fed to a disk encoder that has holes through which the light signal from the infrared radiation sensor enters on the receiving device and depending on the duration and the pulse wave speed can be determined; the disk rotation is due to the screw and reducer. Data from the infrared receiver is sent to the

second input of the microcontroller which processes the incoming signals, then goes through the decoder to the indicator; pulses of a megahertz frequency come from the reference frequency generator to the counting input of the microcontroller; the microcontroller stores information in a buffer device and transmits to transceiver devices over GSM/GPRS cellular networks over a distance.

Figure 3 shows the constructive solution of the developed device for measuring wave strength which contains:

- Float (1);
- Control panels with liquid crystal display (1);
- Disk (3);
- Screw (4);
- Control panel (5);
- Infrared sensor (6);
- Gearbox (7);
- Hydraulic cylinder (8);
- Protective pipe (9);
- Elastic element – spring (10);
- Ultrasonic sensor (11);
- Rod (12);
- Anchor (13).

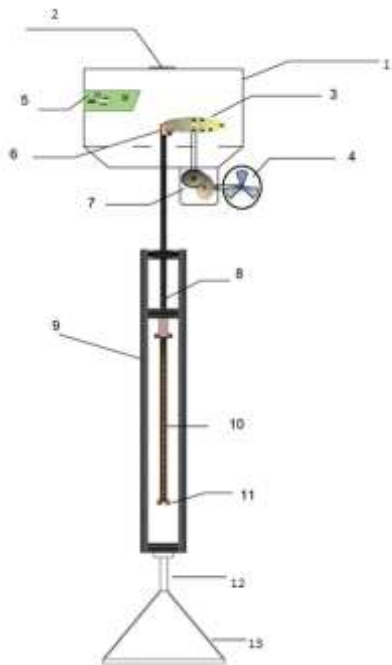

Figure 3 Design of the device for measuring the sea wave

worm gear and an integrating mechanism for counting pulses were installed on the disk shaft, then in this case it would be possible to estimate the average value of the change in the wave speed in one place or another for a certain time interval.

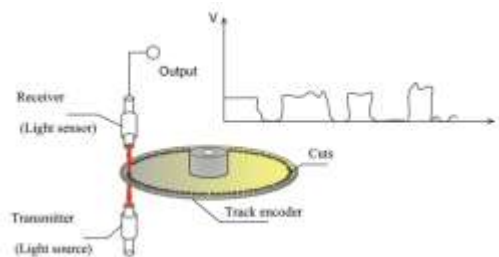

Figure 5 Diagram of the device for measuring the wave speed; a) pulses at the receiver; b)

When the disk rotates, modulated pulses (Fig. 5, b) come from the sensor (Fig. 5, a) which are fed to the microcontroller (Fig. 6) of the electronic unit of the measuring device.

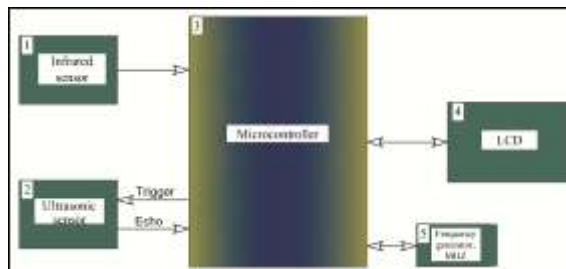

Figure 6 Block diagram of the electronic unit of the measuring device

The following elements were used to measure the wave speed: screw (4), gearbox (7), disk (3), infrared sensor (6). As the wave speed increases, the screw rotation frequency increases. A screw through a reducer causes a disk with holes to rotate (Fig. 4).

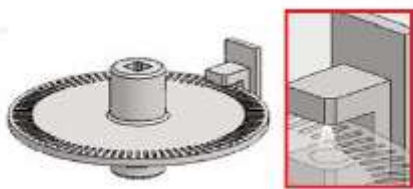

Figure 4 Disk incremental encoder

The disk is an incremental encoder that allows encryption. A stepping optical encoder consists of the following components (Fig. 5): a light source, a tagged disk, a photosensitive sensor and a disk having a certain number of holes through which light from the source hits the photosensitive sensor. When the disk is rotated a series of pulses ($v = f(t)$) comes from the photosensitive sensor the frequency of which is directly proportional to the speed of the wave. If a

The wave speed meter operates in the frequency-pulse modulation mode, i.e. at the output we have pulses modulated in accordance with frequency depending on the speed, length and head of the wave. An increase in the wave speed leads to an increase in the screw rotation frequency and, accordingly,

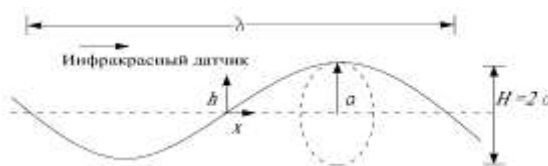

Figure 7 Parameters of the trochoidal wave

In the disk there are m holes: $m=72$.
 n –rotations– 1 M/c.

$$n = f(V)$$

V – speed.
 n – rotational speed.

$$k = \frac{m}{n},$$

where $n=k \cdot m$
 k – is the disk constant.

When the number of measurements on the disk is 72, it means that for every 72 pulses from the sensor, the disk completes a full cycle. To measure the pulse circulation of the wave, it is necessary to calculate the number of pulses generated by the sensors. Suppose that the number of pulses generated per second is equal to 360 pulses; we shall divide it by the number of holes in the disk to get the number of disk cycles equal to 5 cycles per second.

$$k = \frac{m}{n} = \frac{360}{72} = 5 \text{ M/c},$$

Therefore, the wave speed will be $V=18$ km/h.

When the radius of the disk is 25 cm and the number of measurements on the disk is 72, the angle between each measurement is 5 degrees. Let us determine wavelength upon the given values

$$l = 2\pi r$$

$$l = 2\pi \cdot 25 = 157 \text{ cm}$$

Suppose that the disk makes five full rotations $\theta=5 \cdot 360=1800^\circ$, then

$$\lambda = \frac{\theta \cdot l}{360^\circ} = \frac{1800 \cdot 157}{360} = 785 \text{ cm} = 7,85 \text{ m}$$

Wavelength measurement

$$\lambda = \frac{2\pi g}{\omega^2} = \frac{2\pi g}{(2\pi)^2 f^2} = \frac{g \cdot T^2}{2\pi}$$

Or

$$\lambda = \frac{2\pi g}{(2\pi)^2 f^2} = \frac{g}{2\pi f^2}$$

$$\lambda = F(T) \text{ и } \lambda = F(f)$$

T – wave period,
 f – wave frequency.

The wavelength is directly proportional to the square of

the wave period.

The error in measuring the wave speed at $n = 72$

$$\delta = \frac{5 \cdot 100}{360} = 1,4 \%$$

To determine the wavelength – the horizontal distance between two successive wave crests, measured along the direction of propagation, we shall express the frequency (ω), wavelength (λ) and wave period (T) by formulas when considering the trochoidal wave parameters (Fig. 6). Angular speed of the wave is

$$\omega = \frac{2\pi}{T} = 2\pi f ;$$

The length of the wave is

$$\lambda = \frac{2\pi g}{\omega^2}$$

Period is the time interval between two successive wave crests at a fixed point.

$$T = \sqrt{\frac{2\pi\lambda}{g}} = \frac{2\pi}{\omega}$$

The speed of the wave is

$$V = \lambda \cdot f$$

The time interval between two successive wave crests at a fixed point is determined by the formula

$$t = \frac{\lambda}{V}$$

The obtained data on the speed and length of the wave come to block 3 – the microcontroller (Fig. 5). The output of the microcontroller (block 3) is connected to the input of the liquid crystal display (block 4) (Fig. 5) and the results of speed and length of the wave are displayed on the liquid crystal display. If necessary, the data of these values – the speed and

length of the wave can be transmitted through the transmitter or cellular communicator to the recording device of the meteorological monitoring station, if the mentioned device is located a short distance from the coast.

To determine the level of the crest of the wave – the height of the wave it is proposed to use an ultrasonic distancefinder which allows determining the height of the wave H (Fig. 7) according to the principle of operation of the echo sounder. Ultrasonic sensor 11 (Fig. 3) is connected with the float 2 and is mounted in the hydraulic cylinder 8; it is pro-

tected by pipe 9. Its principle of operation is that when the wave height changes simultaneously with the wave, the position of the float changes and ultrasonic pulses are transmitted to the control panel from the sensor of ultrasonic signals, unit 2 (Fig. 6), to the input of the microcontroller, unit 3 (Fig. 6). The microcontroller (4) processes the signal and calibrates it, and from the moment of coming out from the microcontroller this ultrasonic signal, calibrated to the wave height parameter in meters, is transmitted to the reading device – the liquid crystal display 4 (Fig. 6).

The ultrasonic sensor (Fig. 8) emits ultrasonic waves at a frequency of 40 kHz. As an ultrasonic sensor, sensor of type HC-SR04 can be used. The sensor generates a signal that allows determining the distance, and, consequently, the height of the wave $H = 2a$ (Fig. 8).

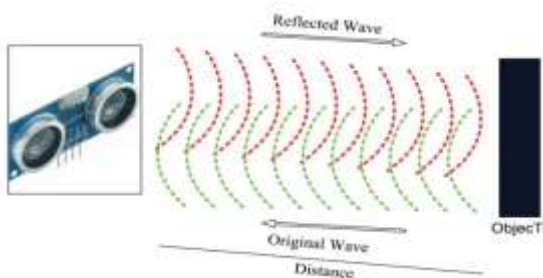

Figure 8 Ultrasonic sensor

The ultrasonic sensor is an ultrasonic module HC-SR04 (Fig. 9) with 4 contacts. Contact 1 (Fig. 9) is supplied with the supply voltage – 5V; contact 2 is supplied with positive pulse 10 μs – radiating, operating in the trigger mode; contact 3 – echo-pin, is supplied with reflected signal; contact 4 is connected to ground – the RW value.



Figure 9 Ultrasonic module HC-SR04

The sensor emits a short ultrasound pulse in the beginning of counting (at time 0) which is reflected from the object and received by the sensor. The distance is calculated from the moment the signal is emitted which is reflected from the object and received by the sensor that is, based on the radiation time and until the echo is received. The speed of sound (Fig. 10).

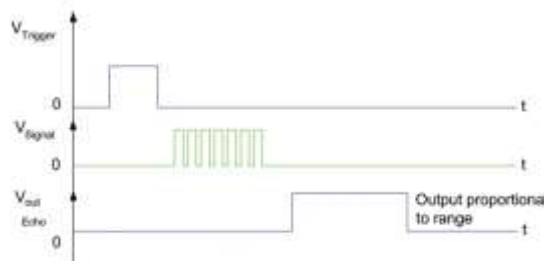

Figure 10 Drawings of output voltage

The sensor receives an echo signal and outputs the distance which is encoded by the duration of the electrical signal at the outlet of the sensor (ECHO). The next pulse can be radiated only after the echo from the previous one disappears. This time is called the cycle period. The recommended period between pulses must be at least 50 ms. If a 10 microsecond pulse is applied to the signal pin (Trigger) (Fig. 10) then the ultrasound module will emit eight packets of an ultrasonic signal at a frequency of 40 kHz and register their ECHO. The measured distance to the object is proportional to the width of the echo and can be calculated by the formula

$$H = \frac{t}{58} ,$$

where t – is the time of the timer (echo signal).

58 – is calibration.

The height of the crest of the wave is determined by the formula

$$a = \frac{t}{58 \cdot 2} , \quad \text{as } H = 2a.$$

The obtained values of the speed, length and height of the wave are fed from the sensors to the microcontroller – 3 (Fig. 5) and recorded on the indicator – 4. A reference generator – 5 (Fig. 6) is provided for the microcontroller to work.

In order to transfer wave parameters to a distance that is, ashore, it is necessary to modulate the signal data of the wave parameters up to 150 MHz for the radio transmitter and install a demodulator on the shore. The power of the transmitter for a voltage of 9V can be done using batteries.

Signals about the parameters of the wave – the height, length and speed of the sea wave at a considerable distance from the coast can be transmitted using wireless communication over cellular networks with further transmission to the Internet. It is possible to transmit data over GSM/GPRS cellular networks using the equipment developed by Energiya-Source LLC, Cheliabinsk. The structural block diagram is presented below (Fig. 11).

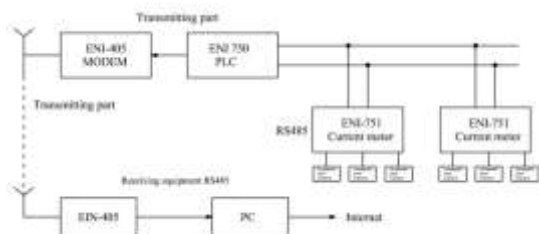

Figure 11 Structural block diagram of wireless data transmission over cellular networks

In the presented block diagram (Fig. 11) of wireless data transmission:

- En I-405 (GSM/GPRS – RS 485/232) is a terminal device (modem) of cellular communication $f = 900/1800$ MHz with a SIM card;

- En I-750 is a programmable logic controller that manages the polling of sensors, the formation, the search for information or an on-line signal (upon request);

- PLC is a programmable logic controller;

- En I-751 – conversion units which measure the current $I = 4-20$ mA from the sensors of the pulse transmission unit (PTU) and transmit it to En I - 750;

- ICU – information conversion units (ICU).

Receiving equipment based on En I - 405 using RS 485 network for connection to a laptop or personal computer (PC).

Further data from the network can be used in any convenient place.

CONCLUSIONS

An electronic device has been developed for measuring the parameters of the sea wave: the speed, height and frequency of the wave.

REFERENCES

- [1] energy of sea waves. http://user.ospu.8dessa.Ua/~shev/emd_m/nie/1_2_9.htm
- [2] A.A. Zagorodnikov ‘Radar survey of sea unrest’, L., Gidrometeoizdat, 1978, p. 141-158.
- [3] F. Onea, L. Rusu. A Long-Term Assessment of the Black Sea Wave Climate, Sustainability 2017, 9, 1875; doi:10.3390/su9101875.
- [4] V. S. Arkhipkin, F. N. Gippius, K. P. Koltermann, G. V. Surkova., Wind waves in the Black Sea: results of a hindcast study. / Hazards Earth Syst. Sci., 14, 2883–2897, 2014.
- [5] V. Galabov. The Black Sea Wave Energy: The Present State and the Twentieth century Changes, /Submitted on 5 Jul 2015.
- [6] ‘Determination of wave parameters by the combined system of measuring the vessel’s speed and wave height’ Vanaev A.P., Cherniavets V.A. – Shipbuilding № 8-9, 1993, p. 6-8.
- [7] ‘Device for measuring wave parameters’ Cherniavets V.V., Vanaev A.P., Nebylov A.V. The patent of the Russian Federation № 2137153, 1999.
- [8] ‘Radiation method for determining the parameters of the sea surface and the device for its implementation’ Patent of the Russian Federation № 2024034, Dobrovolskii D.D., Putiashev N.N., Iakubovskii E.G., 1994.
- [9] V.D. Andreev. Theory of inertial navigation. Moscow, Science, 1966, p. 580.
- [10] Iu.M. Smirnov, G.I. Vorobyov. Specialized computers. Moscow, High School, 1989. – p. 144.
- [11] Set of LSI K 1804 in processors and controllers. V.M. Meshcheriakov, I.E. Lobov, S.S. Glebov et al. – Edited by V.B. Smolova/M., Radio and Communication, 1990, - p. 256.
- [12] Volosov P.S., Dubinko Iu.S. and others. Shipboard satellite navigation systems. – L., Shipbuilding, 1983 – p. 272.
- [13] Rivkin S.S. Determination of linear speeds and accelerations of the ship’s motion by the international method. – L.; Central Research Institute ‘Rubin’, 1980. – p. 180.
- [14] Network satellite radio navigation systems. V.S. Shibshevich, P.P. Dmitriev, N.V. Ivantsevich et al. – M.; Radio and communication, 1982, p. 272.
- [15] Onboard devices of satellite radio navigation/N.V. Kudriavtsev, I.I. Mishchenko, A.I. Volynkin et al. – M.; transport. 1988 – p.201.
- [16] Zaitsev A.V., Reznichenko V.I. Determination of the ship’s ground speed based on signals from the mid-orbit space navigation system // Notes on hydrography. – 1982 – № 208 a. – pp.62-64.
- [17] Wave energy <http://koi.tspu.ru/waves/>
- [18] Shuleikin V.V. Physics of the sea. Publisher science, M., 1968, 1083s UA.

Ahmed M. Alqataa. graduate student , Physics- Dechnology Institute, Department of Power installations based on renewable energy, Baccalaureate, Electrical power and Electrical engineering, Record 15 dated on june 10th, 2014, Master, Electrical Industry and Electrical Technology, Proceedings 9 dated june 15, 2016, 5 articles published, 1 scopus and 4 in journals of the Higher Attestation Commission (HAC), 2 inventions are in print, 2 articles.

Eskender A. Bekirov. Doctor of Technical Sciences professor, Head of Department electric power and electrical engineering, has 7 monographs more than 100 inventions, more than 250 articles.

Ennan R. Murtazaev. Assistant, 4 inventions, 8 articles