

# Mobile Application with Arduino to Improve the Determination of the Ripening Status of the Fruit

<https://doi.org/10.3991/ijim.v16i14.29785>

Michael Cabanillas-Carbonell<sup>1</sup>(✉), Víctor Céspedes-Lluque<sup>2</sup>,  
Miguel Yucra-Calla<sup>2</sup>, José Luis Herrera Salazar<sup>3</sup>

<sup>1</sup>Universidad Privada del Norte, Lima, Perú

<sup>2</sup>Universidad Autónoma del Perú, Lima, Perú

<sup>3</sup>Universidad Norbert Wiener, Lima, Perú

mcabanillas@ieee.org

**Abstract**—The consumption of fruits is related to the enjoyment of good health and the reduction of the appearance of diseases such as obesity. Currently, in the markets the process of determining the state of ripeness of the fruits is carried out by the employees using only their criteria, this method being very broad and tedious when it comes to doing it, for this reason, the present research was developed, in the improvement of the process of determining the state of maturity of the fruits. The article exposes the development of a mobile application with Arduino based on the Scrum methodology, taking as indicators fruit resistance and fruit color. In the case of the first indicator, a comparison was made based on the results obtained with the multimeter and the application, observing a 95.3% in similarity of the values. In the case of the second indicator, 83.9% was obtained in the similarity with respect to the intensity of the colors detected by each fruit through the use of the TCS3200 sensor. It was concluded that the prototype fulfills the function of determining the state of maturity of the fruit through the prototype created in Arduino and the application developed having a minimum margin of error.

**Keywords**—mobile application, Arduino, fruit maturity, IoT, Scrum

## 1 Introduction

Both fruits and vegetables are basic components for a balanced health, as well as for the prevention of different diseases such as obesity, malnutrition, among others [1]. During the organoleptic maturation phase, fruit undergoes evident changes in color, texture, flavor and odor, as well as a variation in the nutrients it contains [2]. In this sense, it is important to know how to recognize the ripening stage of fruits and thus be able to identify if they have the right properties to be consumed, since the amount of vitamins, antioxidants and sugars that they provide for our body depends on it [3].

Today, almost one third of the food currently produced in the world is not used, which means that approximately 1.3 billion tons of food is spoiled or wasted each year, it is staggering to know that about 45% of fruits and vegetables and 20% of meat are not consumed [4], [5]. According to the Food and Agriculture Organization of the

United Nations [6], 13.8% of the food produced is lost from the farm to the retail stage. Regionally, estimates range from 5–6% in Australia and New Zealand to 20–21% in Central and South Asia. In terms of food groups, roots, tubers and oilseed crops show the highest level of losses, followed by fruits and vegetables. It is not surprising that fruits and vegetables suffer high levels of losses, given their highly perishable nature.

In countries such as Peru, 40% of food is rejected during harvesting [7], this is because it does not have the size or quality required by the retailer, says Paulo Yvan, regional director of Yara South Pacific, clarifying that it is the retailers or consumers who reject food because of its appearance, when it is fit for consumption. In the case of apples, for example, the lack of calcium produces a condition called “bitter pit”, which causes stains and marks on the fruit, which is why consumers do not buy this type of food.

According to Ref. [8], up to 20% of an average farmer’s production does not meet the specifications demanded by the market, due to quality aspects such as size, shape, color, sweetness or nutrient content. Consequence of the above a study conducted in 2021 [9], shows the results of the analysis of the food supply chain (FSC) in Peru in the period 2007–2017, evidencing that the average annual food loss and waste (FLW) is 12.8 million tons, representing 47.76% of the FSC.

Currently, most of the fruit sorting work is done manually, this method has several shortcomings, which makes the process very extensive and tedious, generating stress and fatigue. This leads to human errors in the determination of fruit maturity. According to Ref. [10], the traditional manual process increases the time used for the selection of the units, on the contrary, the automated process with industrial robotics maintains a tendency to stability. Robotics is considered one of the new trends in education and is used as a way to enrich learning and promote knowledge building activities [11].

The objective of this research work is to develop a mobile application in conjunction with an electronic device on Arduino, which aims to improve the determination of fruit ripeness in markets. This is done by means of the resistance meter and RGB color sensor, the result obtained is analyzed by the application which provides a report on the state of maturity of the fruit and its nutrients according to their level. This is given in order to generate a new solution in the selection of food through the use of technology, having a great impact on the markets, helping to perform with less time and greater efficiency the selection of fruit according to the state of maturity. Currently this type of technology is not so common to see in the different markets of Lima, allowing it to give an innovative profile.

For a better understanding of this article, it has been organized in six chapters: section 1 Introduction, section 2 contains a bibliographic study of previous research on the subject studied, section 3 presents the methodology detailing the different phases implemented for the prototype under development. Section 4 presents the results of the experiment and the related discussion. Finally, section 5 presents the conclusions on the results presented.

## **2 Bibliographic study**

In recent years, research has been carried out to diagnose the condition of food-stuffs, focused on solving the problem through the use of technology. In this section,

a compilation of the most relevant concepts and research related to this topic is made, with the purpose of analyzing the background in order to support and sustain the proposed prototype to improve the determination of the ripening stage of the fruit.

### 2.1 Fruit ripening

Within the group of regulating foods are fruits, which have a limited shelf life, however they are the ones that mainly provide the body with vitamins and minerals, in addition to being metabolism regulators [12]. According to fruit quality control techniques [13], there are 2 stages of fruit ripening: the physiological ripening stage (completed on the tree) and organoleptic ripening (fruits acquire sensory characteristics), in this second stage is where the fruit is defined as edible or not, with the most evident changes being color, texture, flavor and odor. Therefore, keeping control of the ripening stage of fruits helps to take advantage of their nutrients in a timely manner, because at this stage the levels of glucose, fructose and sucrose increase [14], with a decrease in fiber. Figure 1 shows a color scale corresponding to banana maturity stages, where skin color depends on the amount of starch and sugars contained in the pulp [15].

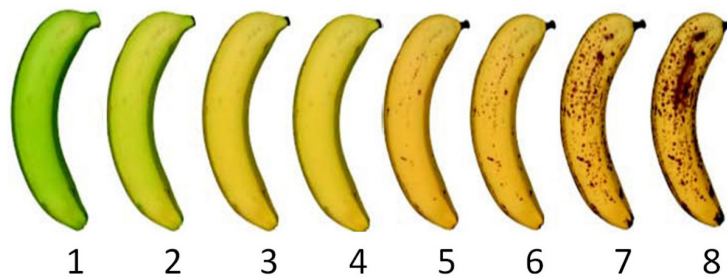

Fig. 1. Stages of banana maturity [16]

According to the classification of banana maturity stage, Figure 2 shows the total sugars and starch obtained according to their index. It can be seen that the riper the fruit, the higher the amount of sugars harmful to health.

Ripening index	Peel colour	Total sugars (%)	Starch (%)
1	Green	0.1–2.0	19.5–21.5
2	Green – trace of yellow	2.0–5.0	16.5–19.5
3	More green than yellow	3.5–7.0	14.5–18.0
4	More yellow than green	6.0–12.0	9.0–15.0
5	Green tips	10.0–18.0	2.5–10.5
6	All yellow	16.5–19.5	1.0–4.0
7	Yellow flecked with brown	17.5–19.0	1.0–2.5
8	Yellow with large brown spots	18.5–19.0	1.0–1.5

Fig. 2. Changes in banana peel color and sugar and starch content [15]

In related research [17], the importance of the consumption of fresh fruits and vegetables for health benefits was highlighted, and it was also pointed out that if the fruits

are not well cared for during pre-harvest, harvest and post-harvest, the percentage that reaches the consumer is considerably reduced due to their physical appearance.

## **2.2 Implementation of ICTs for food selection**

Nowadays smart devices are being used in different areas, so much so that the implementation of mobile applications and electronic equipment on Arduino has become indispensable nowadays in different types of industries [18]–[20], serving as an aid to perform certain specific processes, in addition to improving data acquisition and promoting interconnectivity. This data collection is done through the use of sensors that allow for adequate monitoring [21].

In the articles [22], [23], a review of the advances in the field of Information and Communication Technologies (ICT) with respect to food diagnostics was conducted on a human intervention method that includes checking the freshness of food, through color and odor nuances by means of smartphones in conjunction with multiple electronic components, which offer advantages and improved capabilities over traditional systems. The studies concluded that new technologies have resulted in new diagnostic silver-forms that are more portable, cost-effective and easier to use than conventional laboratory tests.

In Refs. [17], [24] it was highlighted that the use of sensors in industrial processes such as the identification of anomalies in fruits and their separation according to firmness and pigmentation, has managed to minimize fruit damage and avoid losses.

Likewise, due to the increase in food production, an application for the organoleptic testing process was carried out in [25], with the aim of achieving an optimal evaluation of food by means of an algorithm, thus avoiding manual counting. As a result, after the implementation of the application, an accuracy higher than 90% was obtained, highlighting its accuracy in data classification.

Finally, in the research article [26], a computer application was developed that by means of image analysis was able to predict the ripening and classification of papaya fruit according to its ripening stage. An average of 78.1% was obtained in RGB color space.

Studies have shown that electronic devices connected to an application for the identification of food freshness and ripeness have made favorable contributions for future integration within industries.

## **3 Methodology**

The development of the system in general was developed under the Scrum methodology, which allows a good planning of the project development helping to manage workflows and increasing the team productivity; this technique is the most used in software development projects because it allows a better organization and solution of delays [27]. Figure 3 shows the list of stages of the Scrum methodology.

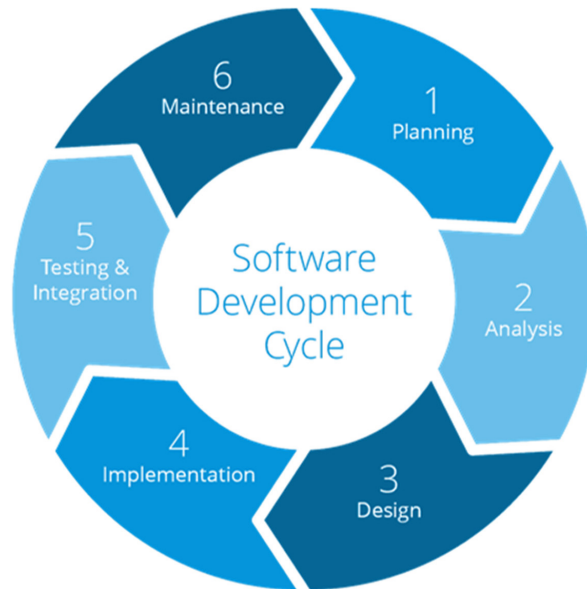

Fig. 3. Stages of the Scrum methodology

### 3.1 Population and sample

To determine the state of maturity of the fruits in the market, a sample of 30 different fruits was taken. The type of sampling was random by randomly selecting fruits of different maturity stages.

### 3.2 Variables and indicators

The independent variable in this research was: the mobile application with Arduino; the dependent variable: determination of the state of maturity of the fruits; the intervening variable according to the research developed is through the Scrum Methodology, see Figure 3.

With respect to the indicators established for the dependent variable, 2 were chosen and are detailed in Table 1.

**Fruit resistance**, according to research on the characterization of the physiological maturity of banana [28], the plant membrane, which maintains fluid balance, behaves as a capacitive element, providing ohmic resistance to the fruit.

**Fruit color**, during the ripening process the chlorophyll accumulated in the pulp tissue decreases, as well as the production of ethylene gas increases, which controls the speed of fruit ripening, so that the green color is increasingly absent, with yellow, orange and red pigments predominating, see Figure 1. These pigments are a source of vitamins and antioxidants [29].

**Table 1.** Variable operation matrix

Indicator	Index	Unit of Measurement	Technique	Instrument
Fruit resistance (KPI 1)	[10–70]	Ohmio ( $\Omega$ )	Observation	Multimeter
Fruit Color (KPI 2)	[60–290]	–	Observation	Color Sensor TCS3200

### 3.3 Design of the architecture of the mobile application with Arduino

After the identification of system requirements, user stories, definition of team roles, as well as the analysis of the problem to identify the population and the indicators to be evaluated, we moved on to the solution design stage. In this stage, the ideas were consolidated and the system architecture (application and Arduino) was developed, and then the development continued.

Figure 4 shows the architecture of the Arduino prototype and the mobile application developed as a solution for the research. To begin with, the hardware part is equipped with an Arduino board, resistance meter and color sensor (RGB), which are responsible for collecting information from the fruit, then through the Bluetooth connection module the data transfer from the Arduino to the mobile application is performed.

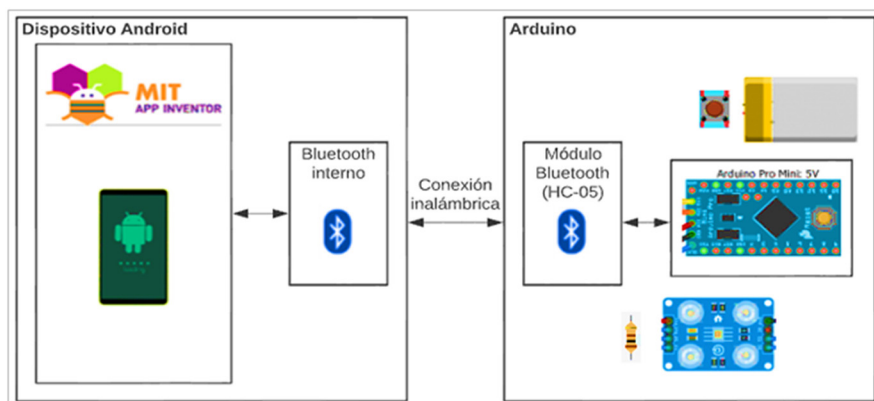

**Fig. 4.** Schematic of the application architecture

### 3.4 Development of the mobile application

The application was developed with AppInventor software, which allows interactive and block programming [30], [31]. Figure 5 shows the programming of the application.

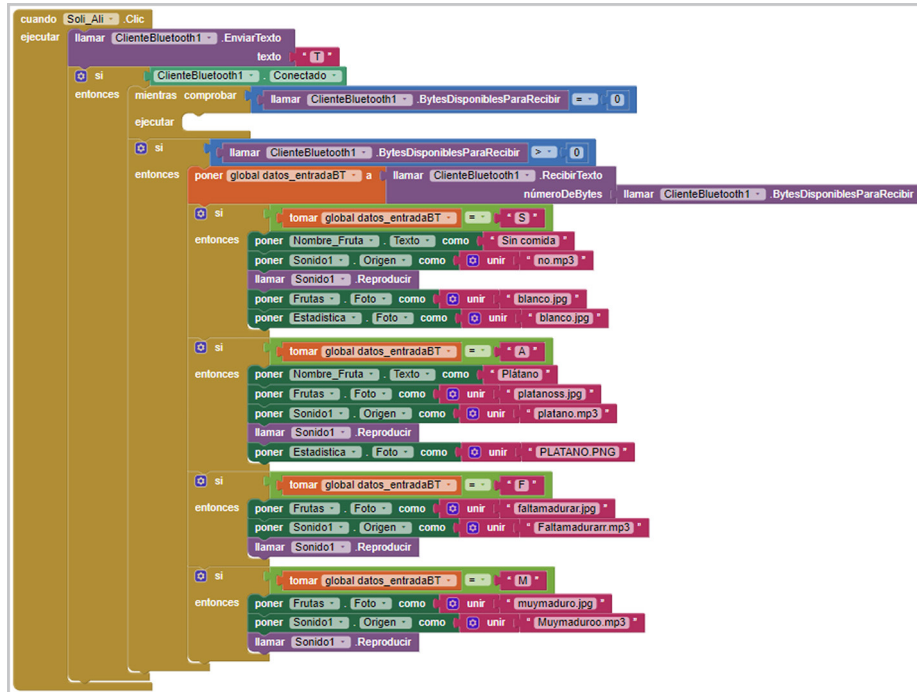

Fig. 5. App inventor code to request maturation data

Figure 6 shows the complete interface of the mobile application visualizing its functions such as Bluetooth connection and disconnection, in addition to the food request button which allows to identify the state of maturity of the analyzed fruit, finally on the back is shown a table with the nutritional information of the fruit, according to its state of maturity.



Fig. 6. Interface of the developed application



### 3.5 Maturity detector prototype

The prototype was developed with the Arduino IDE, performing the programming of the resistance meter and RGB color sensor (TCS3200) which allows detecting an infinite range of colors [32]. Assembled on the board, which identify the stages of ripening of the fruit for subsequent sorting. Figure 7 shows the source code, as well as the tests performed on the prototype in Arduino.

```

if ( verde > 90 && verde < 120, rojo > 85 && rojo < 110, azul >145 && azul < 175 or fruitResistance > 40 & fruitResistance < 70){
  Serial.println("FALTA MADURAR");
  I2CBT.write("F");
}
else if ( verde > 25 && verde < 35, rojo > 36 && rojo < 50, azul > 60 && azul < 80 or fruitResistance > 31 & fruitResistance < 37){
  Serial.println("MADURO");
  I2CBT.write("A");
}
else if ( verde > 200 && verde < 300 , rojo > 150 && rojo < 220, azul > 280 && azul < 320 or fruitResistance > 10 & fruitResistance < 35){
  Serial.println("MUY MADURO");
  I2CBT.write("M");
}
if (verde > 1100 && verde < 1260 , rojo > 1000 && rojo < 1200, azul > 900 && azul < 1100 or fruitResistance > 0 & fruitResistance < 10) {
  Serial.println ("SIN COMIDA");
  I2CBT.print("S");
}
}
}}}
    
```



Fig. 7. Tests to the code in Arduino IDE showing the results of the implemented sensors

Figure 8 shows the development process to achieve the final result of the interaction of the prototype with the developed application. Figure 8(a) shows the first prototype created, which was invasive for the fruit; this section shows the application and the prototype in correct operation. Figure 8(b) shows the second version of the prototype implemented with sensors, in order not to alter the fruit during the test. In Figure 8(c), the connections of the final prototype are shown, as well as the implementation of the battery to make possible its wireless use and the on/off button. Figure 8(d) shows the final wireless Arduino prototype with the connections properly arranged so that they are not exposed to breakage and thus have a better lifetime and durability. Finally, Figure 8(e) shows the final test of the prototype.



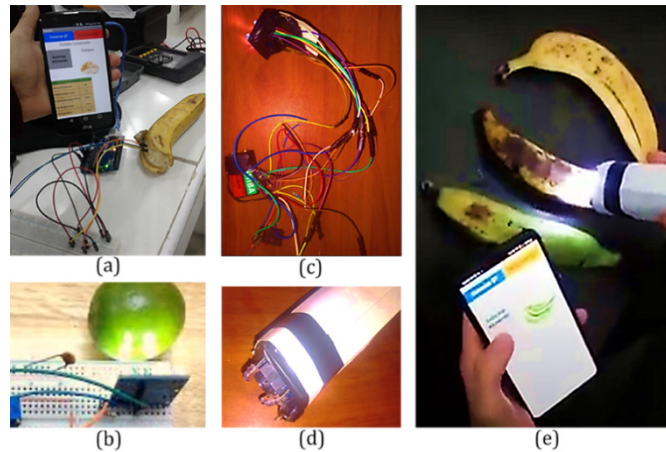

Fig. 8. Prototype development stages and interaction with the application

### 3.6 Data collection

Making use of the prototype in Arduino we observed the results collected from the prototype in the application, shown in Figure 6 and Figure 8(e), in addition to its classification of the ripening state of the fruits through the numerations calculated by the 2 sensors mentioned above. To validate the prototype, technical test criteria such as user stories were taken into account, where those that most directly intervened between the Arduino and the application were evaluated.

## 4 Results and discussions

The type of research of this article was applied, which aims to provide a solution to the specific problem for the productive sector [33], allowing the determination of the state of maturity of the fruits in the markets with the support of the mobile application with Arduino in a useful and effective way. Regarding the level of research, this was descriptive, this is because it describes the development of the mobile application with Arduino. Finally, the research design used was pure experimental.

$$RGe x O_1 \quad (1)$$

$$RGe x O_2 \quad (2)$$

Where:

*R*: Random choice of the elements of the Group.

*Ge*: Experimental group, formed by the representative number of fruits.

*O*<sub>1</sub>: Are the values of the indicators of the dependent variable in the Pre-Test.

*x*: Mobile Application with Arduino.

*O*<sub>2</sub>: The values of the indicators of the dependent variable in the Post-Test (after implementing a solution).

#### 4.1 Descriptive and inferential results

In Table 2, the values of the theoretical and experimental reports are shown.

**Table 2.** Results obtained

N°	KPI 1: Fruit Resistance		KPI 2: Fruit Color	
	Theoretical	Experimental	Theoretical	Experimental
1	61	62	128	91
2	79	65	53	61
3	52	55	150	84
4	52	55	204	166
5	72	70	258	53
6	55	46	186	142
7	41	35	128	52
8	67	67	89	152
9	50	52	83	117
10	49	45	76	98
11	67	61	98	152
12	76	64	137	173
13	66	60	57	55
14	51	50	134	58
15	66	65	66	223
16	61	63	50	121
17	67	51	102	61
18	80	80	149	242
19	54	59	136	161
20	76	70	233	63
21	52	52	157	181
22	70	41	100	141
23	63	55	179	130
24	43	29	70	81
25	45	31	234	58
26	65	36	284	61
27	54	37	121	2161
28	62	50	116	161
29	57	43	135	256
30	81	71	70	113

#### 4.2 Normality test of the results

**Fruit resistance (KPI 1)**, it is observed in Figure 9 that for KPI 1, the theoretical and experimental results were the following  $(0.51 \text{ and } 0.72) > \alpha (0.05)$ . Therefore, the data obtained for the indicator follows a normal behavior.

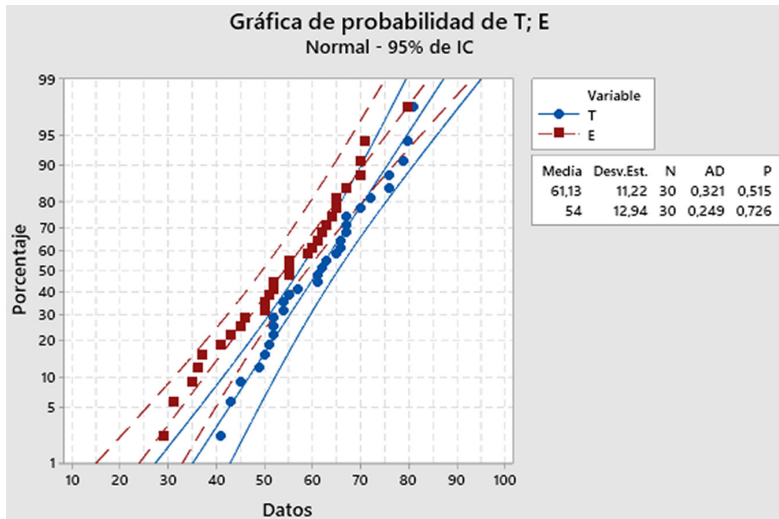

Fig. 9. Normality test—fruit resistance

**Fruit color (KPI 2)**, it is observed in Figure 10 that for KPI 2, the theoretical and experimental results were as follows  $(0.090 \text{ and } 0.081) > \alpha (0.05)$ . Therefore, the data obtained for the indicator follow a normal behavior.

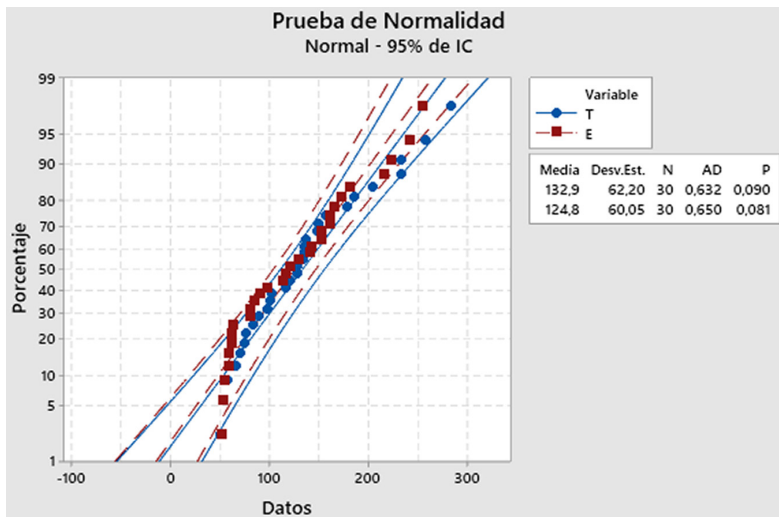

Fig. 10. Normality test—fruit color

### 4.3 Analysis and interpretation of results

For the analysis of the results, it was necessary to compare the tests performed to observe the correct functioning of the system created and validated with the validated instruments.

Figure 11 shows the average result of KPI 1, which shows that there is not much variation between the data from the multimeter and the mobile application with Arduino, with an overall error of 4.73%.

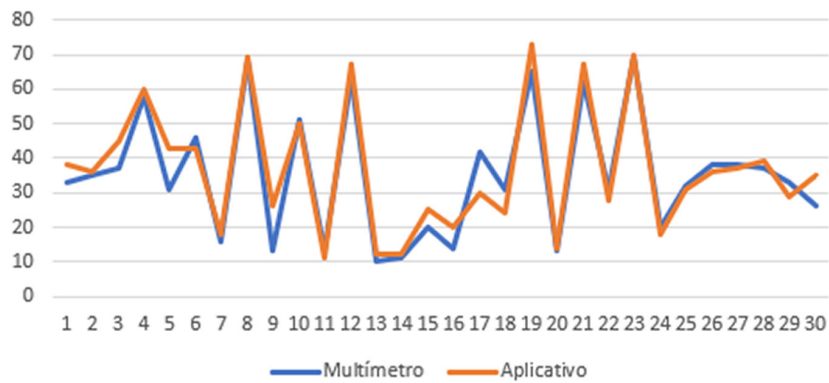

Fig. 11. Graph of similarity between multimeter data and application data

Figure 12 shows the average result of KPI 2, which shows that there is not much variation between the TCS3200 sensor data and the mobile application with the Arduino, with an overall error of 6.09%.

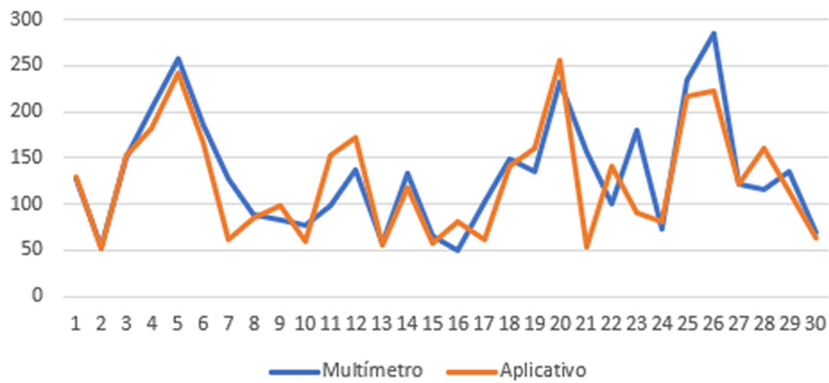

Fig. 12. Graph of similarity between TCS3200 color sensor data and the application

## 5 Conclusions

According to the results obtained, it is evident that, with the use of the mobile application and the Arduino, the values of the resistance of the fruit are correctly determined by entering the ranges established in the Arduino for each fruit, making it possible to detect its state of maturity, with a 95.3% similarity to the values obtained by the multi-meter as an instrument developed, with a margin of error of 4.73% shown in Figure 11.

It is observed that the mobile application and Arduino, is able to identify the color of the fruit accurately due to the intensity of the color it possesses, making it possible to determine its state of maturity through the color in which the fruit is found by means of the TCS3200 sensor, this is observed in Figure 12, having 83.9% in the similarity regarding the intensity of the colors detected by each fruit, with an overall error margin of 6.09%.

It was concluded that both sensors show a minimum margin of error, however, both complement each other for the simultaneous operation of the prototype.

The scientific contribution provided by this research work is very important in the scientific environment because it serves as a basis for future projects that want to implement technologies such as IOT (Internet of Things) through the use of the Arduino and AppInventor software that allows the development of applications in a simple and efficient way [34], [35]; these technologies were implemented in this scientific article for the determination of the ripening state of the fruit in the markets, which in the future could be taken to a larger scale as in the case of food industries.

For future work, it is proposed to implement technologies such as artificial intelligence through machine learning, which would help to detect the ripening state of fruits on a larger scale, being of benefit to the fruit trade.

## 6 References

- [1] World Health Organization, "Healthy diet," WHO, 2020. <https://www.who.int/news-room/fact-sheets/detail/healthy-diet>
- [2] W. Hu, D. W. Sun, H. Pu, and T. Pan, "Recent Developments in Methods and Techniques for Rapid Monitoring of Sugar Metabolism in Fruits," *Compr. Rev. Food Sci. Food Saf.*, vol. 15, no. 6, pp. 1067–1079, Nov. 2016, <https://doi.org/10.1111/1541-4337.12225>
- [3] M. Sarpras, I. Ahmad, A. Rawoof, and N. Ramchiary, "Comparative analysis of developmental changes of fruit metabolites, antioxidant activities and mineral elements content in Bhut jolokia and other Capsicum species," *LWT*, vol. 105, pp. 363–370, May 2019, <https://doi.org/10.1016/j.lwt.2019.02.020>
- [4] Oficina Regional de la FAO para América Latina y el Caribe, "Pérdidas y desperdicios de alimentos en América Latina y el Caribe," Organización de las Naciones Unidas para la Alimentación y la Agricultura (FAO), 2021.
- [5] B. Thumas, "Las nuevas tecnologías ayudan a los supermercados a reducir el desperdicio de alimentos—Alimentación," 2019.
- [6] Food and Agriculture Organization of the United Nations (FAO), *El estado mundial de la agricultura y la alimentación. Progresos en la lucha contra la pérdida y el desperdicio de alimentos.*, vol. 32, no. 3. 2019.
- [7] FAO, OPS, WFP, and UNICEF, "Panorama 2018 De La Seguridad Alimentaria Y Nutricional," ©FAO Jules Tusseau, pp. 820–821, 2018.
- [8] F. Paúl, "Las impactantes cifras que deja el desperdicio de comida en el mundo (y cuáles son sus efectos)," *BBC News Mundo*, 2021.

- [9] N. S. Bedoya-Perales and G. P. Dal' Magro, "Quantification of food losses and waste in Peru: A mass flow analysis along the food supply chain," *Sustain.*, vol. 13, no. 5, pp. 1–15, 2021, <https://doi.org/10.3390/su13052807>
- [10] R. García Sánchez, R. C. García Vacacela, N. Villavicencio Bermudes, and J. Meléndez, "Sistema de robótica industrial en operaciones agroindustriales: optimización del proceso de limpieza y selección de frutas," *Alternativas*, vol. 20, no. 1, 2020, <https://doi.org/10.23878/alternativas.v20i1.274>
- [11] S. Papadakis, "Robots and Robotics Kits for Early Childhood and First School Age," *Int. J. Interact. Mob. Technol.*, vol. 14, no. 18, pp. 34–56, 2020, <https://doi.org/10.3991/ijim.v14i18.16631>
- [12] A. Gay Mendéz, "Nutrición | Colección aula MENTOR," España, 2017.
- [13] J. Brezmes-Llecha, "Técnicas de control de calidad en fruta," *Control Calidad*, pp. 13–34, 2000.
- [14] M. E. Maldonado-Celis et al., "Chemical Composition of Mango (*Mangifera indica* L.) Fruit: Nutritional and Phytochemical Compounds," *Front. Plant Sci.*, vol. 10, p. 1073, Oct. 2019, <https://doi.org/10.3389/fpls.2019.01073>
- [15] A. K. Thompson, S. Supapvanich, and J. Sirison, "Introduction," in *Banana Ripening: Science and Technology*, 1st ed., Springer International Publishing, 2019, pp. 2–3. [https://doi.org/10.1007/978-3-030-27739-0\\_1](https://doi.org/10.1007/978-3-030-27739-0_1)
- [16] P. Escalante-Minakata et al., "Optimización de la extracción enzimática de jugo de banano a partir de los cultivares enano gigante, FHIA-17 y FHIA-23," *Univ. y Cienc.*, vol. 29, no. 1, pp. 1–9, 2013.
- [17] E. Fiestas Sorogastúa and S. Prado Gardini, "Sensores tipo fruto electrónico: Aplicabilidad en procesos agroindustriales y metodología para su desarrollo," *Sci. Agropecu.*, vol. 9, no. 3, pp. 441–459, Sep. 2018, <https://doi.org/10.17268/sci.agropecu.2018.03.16>
- [18] L. T. Khrais, "Investigation use of Social Media, Mobile Apps, and the impacts of Enlarging E-Commerce," 2020 6th Int. Conf. Adv. Comput. Commun. Syst. ICACCS 2020, pp. 1365–1372, 2020, <https://doi.org/10.1109/ICACCS48705.2020.9074341>
- [19] J. Ríos-Kavadoy, H. Guerrero-Bello, and M. Cabanillas-Carbonell, "Intelligent Scroll Order Generator Software from View Movements in People with Disabilities," *Int. J. Adv. Comput. Sci. Appl.*, vol. 12, no. 5, pp. 295–302, 2021, <https://doi.org/10.14569/IJACSA.2021.0120536>
- [20] M. A. Cabanillas-Carbonell and J. E. Zapata-Paulini, "Non-invasive vital signs monitoring system with real-time caution and emergency alerts," 2019 7th E-Health Bioeng. Conf. EHB 2019, Nov. 2019. <https://doi.org/10.1109/EHB47216.2019.8970047>
- [21] A. Alam, A. Das, S. Tasjid, and A. Al Marouf, "Leveraging Sensor Fusion and Sensor-Body Position for Activity Recognition for Wearable Mobile Technologies," *Int. J. Interact. Mob. Technol.*, vol. 15, no. 17, pp. 141–155, 2021, <https://doi.org/10.3991/ijim.v15i17.25197>
- [22] G. Rateni, P. Dario, and F. Cavallo, "Smartphone-based food diagnostic technologies: A review," *Sensors (Switzerland)*, vol. 17, no. 6, 2017, <https://doi.org/10.3390/s17061453>
- [23] P. S. Jayakumar, A. C. Hedge, S. Lakshmi, N. Shivprasad, and K. Rakshitha, "A literature review on techniques to detects food freshness," *Int. J. Sci. Res. Eng. Dev.*, vol. 3, no. 3, pp. 433–436, 2020.
- [24] C. H. Crisosto, G. M. Crisosto, and J. R. Bermejo, "Aplicación de sensores no destructivos para mejorar la satisfacción de los consumidores de frutas frescas y el aumento de su consumo," Department of Plant Sciences, University of California, Davis, U.S.A, 2018.
- [25] R. Tanone and H. B. Prasetya, "Designing and implementing an organoleptic test application for food products using android based decision tree algorithm," *Int. J. Interact. Mob. Technol.*, vol. 13, no. 10, pp. 134–149, 2019, <https://doi.org/10.3991/ijim.v13i10.9669>
- [26] L. F. Santos Pereira, S. Barbon, N. A. Valous, and D. F. Barbin, "Predicting the ripening of papaya fruit with digital imaging and random forests," *Comput. Electron. Agric.*, vol. 145, pp. 76–82, Feb. 2018, <https://doi.org/10.1016/j.compag.2017.12.029>

- [27] Z. Ereiz and D. Music, "Scrum Without a Scrum Master," 2019 IEEE Int. Conf. Comput. Sci. Educ. Informatiz. CSEI 2019, pp. 325–328, 2019, <https://doi.org/10.1109/CSEI47661.2019.8938877>
- [28] J. C. Caicedo-Eraso, L. F. Mejía Gutiérrez, and F. O. Díaz Arango, "Caracterización de la madurez fisiológica del plátano dominico harton por espectroscopia de impedancia eléctrica," *Vitae*, vol. 23, pp. S199–S203, 2016.
- [29] M. Martínez-González et al., "Poscosecha de frutos: maduración y cambios bioquímicos," *Rev. Mex. Ciencias Agrícolas*, vol. 19, pp. 4075–4087, 2017, Accessed: Mar. 24, 2022. <https://doi.org/10.29312/remexca.v0i19.674>
- [30] N. Christofi, E. G. P. B, and I. S. Paraskevas, "The Combined Use of Lego Mindstorms NXT and App Inventor for Teaching Novice Programmers," *Educ. Robot. Makers Era*, vol. 560, pp. 193–204, 2016. [https://doi.org/10.1007/978-3-319-55553-9\\_15](https://doi.org/10.1007/978-3-319-55553-9_15)
- [31] S. Papadakis, M. Kalogiannakis, V. Orfanakis, and N. Zaranis, "The Appropriateness of Scratch and App Inventor as Educational Environments for Teaching Introductory Programming in Primary and Secondary Education," *Int. J. Web-Based Learn. Teach. Technol.*, vol. 12, no. 4, pp. 58–77, Oct. 2017, <https://doi.org/10.4018/IJWLTT.2017100106>
- [32] DFRobot, "TCS3200 Color Sensor (SKU: SEN0101)," 2017.
- [33] I. M. Schwarz, "Guía de referencia para la elaboración de una investigación aplicada," Lima, Peru, 2017.
- [34] S. Papadakis, "Evaluating a Teaching Intervention for Teaching STEM and Programming Concepts Through the Creation of a Weather-Forecast App for Smart Mobile Devices," in *Handbook of Research on Tools for Teaching Computational Thinking in P-12 Education*, IGI Global, 2020, pp. 31–53. <https://doi.org/10.4018/978-1-7998-4576-8.ch002>
- [35] N. Zaranis, V. Orfanakis, S. Papadakis, and M. Kalogiannakis, "Using Scratch and App Inventor for teaching introductory programming in Secondary Education. A case study," *Int. J. Technol. Enhanc. Learn.*, vol. 1, no. 1, p. 1, 2016, <https://doi.org/10.1504/IJTEL.2016.10001505>

## 7 Authors

**Michael Cabanillas-Carbonell** is a qualified researcher by the National Council of Science, Technology and Innovation—Peru. Professor of Computer Systems Engineering at Universidad Privada del Norte. President of the IEEE-Peru Education Society Chapter. Conference Chair EIRCON (Engineering International Research Conference). (email: [mcabanillas@ieee.org](mailto:mcabanillas@ieee.org))

**Víctor Céspedes-Lluque** is a graduate of the professional school of Systems Engineering at the Universidad Autónoma del Perú, with extensive experience in software development. (email: [celluquev@autonoma.edu.pe](mailto:celluquev@autonoma.edu.pe))

**Miguel Yucra-Calla** is a graduate of the professional school of Systems Engineering at the Universidad Autónoma del Perú, with extensive experience in mobile application development. (email: [myucrac@autonoma.edu.pe](mailto:myucrac@autonoma.edu.pe))

**José Luis Herrera Salazar** is Academic Director of the Professional School of Engineering at Norbert Wiener University, has extensive experience in virtual and augmented reality, and has several international publications. (email: [joseluis.herrera@uwiener.edu.pe](mailto:joseluis.herrera@uwiener.edu.pe))

Article submitted 2022-01-26. Resubmitted 2022-05-24. Final acceptance 2022-05-24. Final version published as submitted by the authors.