

A Novel PSO-Based Modified SMC for Designing Robust Load-Frequency Control Strategies

Ngoc-Khoat Nguyen

Faculty of Control and Automation, Electric Power University, Vietnam
khoatnn@epu.edu.vn (corresponding author)

Duy-Trung Nguyen

Faculty of Control and Automation, Electric Power University, Vietnam
trungnd@epu.edu.vn;

Thi-Mai-Phuong Dao

Faculty of Electrical Engineering, Hanoi University of Industry, Vietnam
daophuong@hau.edu.vn

Received: 18 April 2023 | Revised: 5 May 2023 | Accepted: 17 May 2023

Licensed under a CC-BY 4.0 license | Copyright (c) by the authors | DOI: <https://doi.org/10.48084/etasr.5972>

ABSTRACT

In an electric power grid, Load-Frequency Control (LFC) plays a crucial role as it aims to maintain the system frequency at a nominal value, 50 or 60 Hz, by minimizing the effects of load changes. However, a modern power system is currently characterized by a huge number of nonlinearities and uncertainties, making control methodologies much more challenging. Among them, the nonlinear features of Governor Dead-Band (GDB) and Generation Rate Constraint (GRC) strongly affect the accuracy and performance of LFC applied to a power network. This study focused on designing an applicable and efficient LFC by proposing a novel Sliding-Mode Control (SMC) scheme. The traditional SMC can successfully solve several nonlinear control problems, and in case of having a reasonable adjustment, it is completely suitable to design the LFC strategy. The modified SMC, integrated with an effective optimization technique, i.e., Particle Swarm Optimization (PSO), can dramatically improve the performance of LFC. This paper presents numerical simulation results implemented in MATLAB/Simulink to demonstrate the feasibility and effectiveness of the proposed control strategy.

Keywords-LFC; mSMC; PSO; nonlinearities; robust control

I. INTRODUCTION

Electricity consumption in a power system changes continuously and randomly over time, causing imbalances between load and demand, and therefore affecting the network frequency, which is one of the most important parameters in an electric power grid, forcing it to oscillate and deviate from the nominal value. As a result, the power system cannot maintain stable and economical operation. The Load-Frequency Control (LFC) control strategy aims to deal with this problem and bring the network back to stability and efficiency [1-10]. A practical power system is usually characterized by nonlinearities, such as Governor Dead-Band (GDB) and Generation Rate Constraint (GRC), which strongly affect the stability of a power system and make the implementation of LFC highly challenging [3-5]. In this aspect, applying traditional regulators, such as PI or PID, or modern controllers, based on fuzzy logic or neural networks, to efficiently solve the LFC issue cannot obtain

acceptable performance. Therefore, it is essential to design a robust control method to tackle the nonlinearities of a practical power system for frequency regulation.

Sliding Mode Control (SMC) is known as a robust and efficient control strategy, which is typically adopted to deal with not only nonlinearities but also with the uncertainties of a system [11-23]. Therefore, it has also been successfully applied to solve the LFC of a power system considering nonlinearities [10]. The current paper proposes a novel robust SMC-based LFC, which is modified from the fundamental SMC strategy. This robust control strategy is capable of dealing with the nonlinearities of a power system, especially the GDB and GRC characteristics. The proposed control scheme was simulated and numerically analyzed in MATLAB/Simulink, was compared with the PID regulator and the fuzzy logic controller, and the results obtained verified its feasibility and superiority.

II. RELATED WORKS

LFC has been studied and applied in practical power systems for decades and a huge number of controllers have been proposed. In [2], several traditional LFC regulators, such as Integral (I), Proportional-Integral (PI), and Proportional-Integral-Derivative (PID) were proposed. In [10], an effective integration of a PI-type fuzzy logic controller with suitable optimization techniques was introduced to address the LFC problem of an interconnected power system. In [4], several intelligent LFC controllers were presented, which exhibited feasible control performance. Among them, the SMC-based schemes applied for LFC have attracted the interest of researchers due to their ability to solve the control issues of uncertain and nonlinear power grids [12-14]. In [11], a control strategy was proposed using BESS based on an adaptive fuzzy super-twisting SMC method for a power system using wind energy. In [17], a new discrete-time SMC was proposed, using a state estimation method based on the fast sampling of measured output variables for the LFC in control areas of a power system consisting of thermal and hydropower plants. A new high-order adaptive SMC with a minimizing chattering mechanism was presented in [23]. In these studies, the SMC schemes had fixed internal parameters and might not be optimized. This characteristic may lead to a shortcoming that can be improved by an optimization technique. This study aimed to solve this issue by designing a modified SMC (mSMC) strategy based on Particle Swarm Optimization (PSO), which is one of the most well-known evolutionary optimization algorithms.

III. TRADITIONAL SLIDING MODE CONTROL - AN OVERVIEW

As mentioned above, SMC is a robust control strategy that addresses the nonlinearities and uncertainties of a system. To make a quick review of the SMC scheme, let's consider a simple case of a Single Input Single Output (SISO) nonlinear control system below [16, 19]:

$$\begin{cases} \dot{x} = Ax + Bu = f(x) + g(x).u \\ y = Cx + Du = h(x) \end{cases} \quad (1)$$

where $x = [x_1, x_2, \dots, x_n]^T \in \mathfrak{R}^n$ is a state vector of the control system, $u \in \mathfrak{R}$ is the input control signal, $y \in \mathfrak{R}$ is the output signal, $A, B, C,$ and D are state matrices for input and output vectors, $f(x) \in \mathfrak{R}^n$ and $g(x) \in \mathfrak{R}^n$ are two functions describing the dynamics of the system, and $h(x) \in \mathfrak{R}$ is a function representing a relationship between the state vector x and the output y . It is required that the real output signal $y(t)$ should track the desired output $y_d(t)$, meaning that the error e between them must satisfy

$$\lim_{t \rightarrow \infty} |y(t) - y_d(t)| = 0 \quad (2)$$

Assuming that it is possible to differentiate the system (1) a number of n times, one can be obtained as:

$$y^{(n)} = a(x) + b(x).u \quad (3)$$

where:

$$a(x) = L_f^n h(x)$$

$$b(x) = L_g L_f^{n-1} h(x) \neq 0$$

$$L_f h(x) = \frac{\partial h(x)}{\partial x} f(x) = \left[\frac{\partial h(x)}{\partial x_1}, \dots, \frac{\partial h(x)}{\partial x_n} \right] [f_1(x), \dots, f_n(x)]^T$$

$$L_f^k h(x) = \frac{\partial L_f^{k-1} h(x)}{\partial x} f(x)$$

$$L_g L_f^k h(x) = \frac{\partial L_f^k h(x)}{\partial x} g(x)$$

The error between the desired and real output signals can be calculated as:

$$e(t) = y(t) - y_d(t) \quad (4)$$

This error and its differentials are used to determine the following function:

$$\sigma = e^{(n-1)} + \xi_1 e^{(n-2)} + \dots + \xi_{n-2} \dot{e} + \xi_{n-1} e \quad (5)$$

where n coefficients ξ_i ($i = 1, 2, \dots, n$) are positive real numbers and they must be chosen to satisfy the Hurwitz polynomial:

$$\Delta(s) = s^{n-1} + \xi_1 s^{n-2} + \dots + \xi_{n-2} s + \xi_{n-1} \quad (6)$$

It is clear that all roots of the equation $\Delta(s)=0$ decide the transient response of the process given in (2) with the following constraint:

$$\sigma = e^{(n-1)} + \xi_1 e^{(n-2)} + \dots + \xi_{n-2} \dot{e} + \xi_{n-1} e = 0 \quad (7)$$

Equation (7) defines a sliding surface with the characteristic polynomial $\Delta(s)$ indicated in (6). The purpose of the control methodology is to force $y(t)$ to track the reference signal $y_d(t)$ with an acceptable tolerance. This requirement is converted into a simple control problem: determination of a control signal $u(t)$ to meet $\sigma \rightarrow 0$.

To prove the above statement, let's select a Lyapunov function as follows:

$$V = \frac{1}{2} \sigma^2 \quad (8)$$

The first-order differential of (8) is:

$$\dot{V} = \sigma \dot{\sigma} \quad (9)$$

The control signal $u(t)$ needs to be chosen to satisfy the following constraint:

$$\dot{V} = \sigma \dot{\sigma} < 0 \quad (10)$$

From (5), it is straightforward to deduce the following:

$$\dot{\sigma} = e^{(n)} + \xi_1 e^{(n-1)} + \dots + \xi_{n-2} \ddot{e} + \xi_{n-1} \dot{e} = y^{(n)}(t) - y_d^{(n)}(t) + \sum_{k=1}^{n-1} \xi_{n-k} e^{(k)} \quad (11)$$

which in combination with (3) can give:

$$\dot{\sigma} = -y_d^{(n)}(t) + a(x) + b(x).u + \sum_{k=1}^{n-1} \xi_{n-k} e^{(k)} \quad (12)$$

The control signal vector $u(t)$ is selected to satisfy:

$$\dot{\sigma} = -K \text{sign}(\sigma) \quad (13)$$

where K is a positive real number. Eventually, the control signal $u(t)$ is:

$$u(t) = \frac{1}{b(x)} [y_d^{(n)}(t) - a(x) - \sum_{k=1}^{n-1} \xi_{n-k} e^{(k)} - K \text{sign}(\sigma)] \quad (14)$$

With the above control law, the first-order differential of the Lyapunov function can be computed as:

$$\dot{V} = \sigma \dot{\sigma} = -K \sigma \text{sign}(\sigma) = -K |\sigma| < 0 (\forall \sigma \neq 0) \quad (15)$$

The statement mentioned in (15) clarifies the asymptotical stability of the given control system according to Lyapunov's theory. The following section presents a modified SMC strategy applied to the LFC proposition.

IV. MODIFIED SMC STRATEGY APPLIED TO THE LFC PROBLEM

A modified control scheme needs to be proposed to apply SMC as a more effective strategy.

A. The Modified SMC Strategy

Several SMC methods deal with the nonlinear control problem. The SMC method presented in the previous section is one of the fundamental versions and has been widely applied to simple SISO systems. A modified version of SMC was considered to create a more efficient LFC scheme for practical power systems with nonlinearities and uncertainties (i.e., GDB and GRC). Recall the state-space model of a nonlinear system in the following form:

$$\begin{cases} \dot{x}^{(n)} = a(x, \dot{x}, \ddot{x}, \dots, x^{(n-1)}, t) + b(x, t) \cdot u(t) \\ y^{(n)}(t) = x^{(n)}(t) \end{cases} \quad (16)$$

In this aspect, the sliding surface can be defined as follows:

$$\sigma(x, t) = \left(\frac{d}{dt} + \lambda\right)^{(n-1)} \cdot e(t) \quad (17)$$

where $e(t)$ is the error for the time between the real and the desired output, as mentioned in (4). When compared with the traditional sliding surface indicated in (5), it is clear that all coefficients ξ_i have been replaced with only one factor λ (17). It is highly significant to seek the optimal factors because the number of variables to be optimized has been dramatically reduced. Therefore, this is the first proposed modification of the SMC strategy.

As mentioned above, the crucial idea of SMC is to design the switching control law in a suitable way to assure the stability of the nonlinear system. The system state needs to be landed on the sliding surface and reach zero even in case of occurring disturbances. To design an appropriate switching law, the sliding surface mentioned in (17) needs to be carefully taken into consideration. Differentiating this function gives:

$$\sigma(x, t) = \left(\frac{d}{dt} + \lambda\right)^n e(t) = \sum_{k=0}^{n-1} \frac{d^{n-k}}{(dt)^{n-k}} \lambda^k e(t) \quad (18)$$

Similar to (11), combining (17) and (15), can give:

$$\dot{\sigma}(x, t) = x^{(n)}(t) - x_d^{(n)}(t) + \lambda^n [x(t) - x_d(t)] + \sum_{k=1}^{n-1} \frac{d^{n-k}}{(dt)^{n-k}} \lambda^k e(t) =$$

$$-x_d^{(n)}(t) + [a(x, \dot{x}, \ddot{x}, \dots, x^{(n-1)}, t) + b(x, t)u(t)] + \lambda^n [x(t) - x_d(t)] + \sum_{k=1}^{n-1} \frac{d^{n-k}}{(dt)^{n-k}} \lambda^k e(t) \quad (19)$$

where $\sum_{k=1}^{n-1} \frac{d^{n-k}}{(dt)^{n-k}} \lambda^k e(t) = \underline{Q}^{(k)}$ describes the lower-order nonlinear systems. These systems have lower order than n , and they can be omitted in a particular perspective on taking care of the n -order nonlinear system. It is assumed that the nonlinear part $a(x, \dot{x}, \ddot{x}, \dots, x^{(n-1)}, t)$ can be estimated as $\bar{a}(x, \dot{x}, \ddot{x}, \dots, x^{(n-1)}, t)$. When the derivative of the sliding surface reaches zero, an estimate control law can be calculated:

$$\bar{u}(t) = \frac{1}{b(x,t)} [-\bar{a}(x, \dot{x}, \ddot{x}, \dots, x^{(n-1)}, t) + x_d^{(n)}(t) + \lambda^n (x(t) - x_d(t)) + \underline{Q}^{(k)}] \quad (20)$$

The switching control law here can be chosen as:

$$u(t) = \bar{u}(t) - \frac{K}{b} \text{sign}(\sigma) \quad (21)$$

where $\bar{u}(t)$ is computed from (20). To testify to the stability of the control law given in (20), a Lyapunov function candidate similar to (8) can be selected as follows:

$$V(\sigma) = \frac{1}{2} \sigma^2 \quad (22)$$

From (19) and (21), omitting the lower-order systems, the following can be achieved:

$$\dot{\sigma} = [a(x, \dot{x}, \dots, x^{(n-1)}, t) - \bar{a}(x, \dot{x}, \dots, x^{(n-1)}, t)] - K \text{sign}(\sigma) \quad (23)$$

Assuming that the tolerance of the estimate is small enough, it is straightforward to deduce the following equation:

$$\dot{\sigma} \approx -K \cdot \text{sign}(\sigma) \quad (24)$$

In this perspective, the derivative of the Lyapunov function candidate is expressed as

$$\dot{V}(\sigma) = \sigma \cdot \dot{\sigma} = -K \cdot \sigma \cdot \text{sign}(\sigma) = -K \cdot |\sigma| \leq 0 \forall \sigma \quad (25)$$

It is obvious from (25) that the modified control law presented in (21) can be asymptotically stable according to Lyapunov's theory. Hence, it can be applied to solve the LFC problem of an electric power interconnection with nonlinearities and uncertainties.

B. The Robust SMC-based LFC Scheme

A power system with nonlinearities, such as GDB and GRC, may be of a control plant which is difficult to apply the LFC strategies. In this context, the modified SMC method, as mentioned previously, is capable of being a robust and efficient control solution. To clarify the superiority of the proposed LFC strategy based on the modified SMC, let's consider a single-area power system using a non-reheat turbine as shown in Figure 1. The GDB and GRC are also considered for this electric power grid. Four steps need to be executed to design a robust SMC-based LFC strategy.

1) Step 1: Build an Ordinary Differential Equation (ODE) Model for the Given Control Plant

As shown in Figure 1, the ODE model can be built as follows. First, let the deviation of system frequency Δf be set as

a state variable x . From Figure 1, considering the load-machine model, it is straightforward to yield the following:

$$x(s) = \Delta f(s) = (\Delta P_T(s) - \Delta P_L(s)) \frac{K_p}{1+sT_p} \quad (26)$$

$$\Delta P_T(s) = \Delta P_L(s) + \frac{T_p}{K_p} x(s)s + \frac{1}{K_p} x(s) \quad (27)$$

Thereafter, considering the non-reheat turbine model:

$$\Delta P_T(s) = (\Delta X_G(s) - \Delta P_T(s)) \frac{1}{T_T} \cdot \frac{1}{s} \quad (28)$$

and combined with (27), it is easy to get:

$$\Delta X_G(s) = \Delta P_L(s) + \frac{T_p}{K_p} x(s)s + \frac{1}{K_p} x(s) + \Delta P_L(s)T_Ts + \frac{T_T T_p}{K_p} x(s)s^2 + \frac{T_T}{K_p} x(s)s \quad (29)$$

From (29), the corresponding ODE model can be obtained as follows:

$$\Delta X_G(t) = \Delta P_L(t) + \frac{T_p}{K_p} \dot{x}(t) + \frac{1}{K_p} x(t) + T_T \Delta \dot{P}_L(t) + \frac{T_T T_p}{K_p} \ddot{x}(t) + \frac{T_T}{K_p} \dot{x}(t) \quad (30)$$

From a governor model, a relationship between control signal u and valve/gate position change ΔX_G can be described as:

$$\left[u(s) - \frac{1}{R} x(s) \right] \frac{1}{1+sT_G} = \Delta X_G(s) \quad (31)$$

The corresponding ODE model is:

$$\Delta \dot{X}_G(t) = \frac{1}{T_G} \left[u(t) - \frac{1}{R} x(t) - \Delta X_G(t) \right] \quad (32)$$

Differentiating (30), and then substituting it for (32), the final ODE model is yielded below:

$$\ddot{x}(t) = -\left(\frac{1}{T_G} + \frac{1}{T_T} + \frac{1}{T_p} \right) \ddot{x}(t) - \left(\frac{1}{T_G T_T} + \frac{1}{T_T T_p} + \frac{1}{T_p T_G} \right) \dot{x}(t) - \left(\frac{K_p}{R T_G T_T T_p} + \frac{1}{T_G T_T T_p} \right) x(t) - \frac{K_p}{T_p} \Delta \dot{P}_L(t) - \frac{K_p}{T_G T_p} \Delta \dot{P}_L(t) - \frac{K_p}{T_G T_T T_p} \Delta P_L(t) + \frac{K_p}{T_G T_T T_p} u(t) \quad (33)$$

2) Step 2: Designing the Sliding Surface

The ODE model in (33) has an order of three, thus a two-order sliding surface should be selected below:

$$\sigma(x, t) = \left(\frac{d}{dt} + \lambda \right)^2 = \ddot{e}(t) + 2\lambda \dot{e}(t) + \lambda^2 e(t) \quad (34)$$

It is noted that the desired frequency deviation should be equal to zero, hence, one can be obtained below:

$$e(t) = x(t) - x_d(t)|_{x_d(t)=0} = x(t) \quad (35)$$

From (34) and (35), the derivative of the sliding surface is:

$$\dot{\sigma}(x, t) = \ddot{x}(t) + 2\lambda \dot{x}(t) + \lambda^2 x(t) \quad (36)$$

3) Step 3: Designing the Equivalent Control Law

From (36), letting the derivative of the sliding surface be equal to zero gives:

$$\ddot{x}(t) = -2\lambda \dot{x}(t) - \lambda^2 x(t) \quad (37)$$

Combining the above equation with (33), it is clear to establish an estimate of the control signal as follows:

$$\bar{u}(t) = \frac{1}{K_p} (T_G T_T + T_T T_p + T_p T_G - 2\lambda T_G T_T T_p) \ddot{x}(t) + \frac{1}{K_p} (T_p + T_G + T_T - \lambda^2 T_G T_T T_p) \dot{x}(t) + \left(\frac{1}{R} + \frac{1}{K_p} \right) x(t) + T_G T_T \Delta \ddot{P}_L(t) + T_T \Delta \dot{P}_L(t) + \Delta P_L(t) \quad (38)$$

4) Step 4: Designing the Sliding Control Law

As mentioned in (20), the sliding control law can be:

$$u(t) = \bar{u}(t) - K \text{sign}(\sigma) = \frac{1}{K_p} (T_G T_T + T_T T_p + T_p T_G - 2\lambda T_G T_T T_p) \ddot{x}(t) + \frac{1}{K_p} (T_p + T_G + T_T - \lambda^2 T_G T_T T_p) \dot{x}(t) + \left(\frac{1}{R} + \frac{1}{K_p} \right) x(t) + T_G T_T \Delta \ddot{P}_L(t) + T_T \Delta \dot{P}_L(t) + \Delta P_L(t) - K \text{sign}(\sigma) \quad (39)$$

V. THE ELECTRIC POWER SYSTEM UNDER STUDY

Figure 2 shows the simulated model built, in MATLAB/Simulink, to investigate the applicability of the proposed SMC-based LFC strategy in dealing with the nonlinearities of a power system (i.e. GDB and GRC). This model includes a power system with the nonlinearities of GDB and GRC. The simulation parameters are presented in [2]. In addition, an SMC controller was built to create the control signal to the governor, to automatically modulate the opening angle of the heat steam valve of the turbine through the governor response. This control manner can hereby maintain the system frequency at the nominal value within an acceptable tolerance. To clarify the superiority of the proposed SMC controller over the conventional LFC regulators, a PID [2] and a fuzzy logic [24] counterpart were also considered.

When performing numerical simulations, the nonlinearities including GDB and GRC are chosen as in [2]. It should be noted that the PSO algorithm was adopted to determine three parameters, as it is one of the most effective optimization techniques [25]. The optimization mechanism begins with a random solution which is defined as initialization. The aim is to find the optimal solution by iterations similar to generations in the genetic algorithm. Each solution must be evaluated by an objective or a fitness function. The candidate fitness function selected in this study is:

$$\text{fitness} = f_{ITAE} = \int_0^T |\Delta f(t)| \cdot t dt \quad (40)$$

where T denotes a simulation time. This fitness candidate was similarly employed to an Integration of Time and Absolute Error (ITAE) control criterion.

Three parameters need to be optimized: K and λ indicated in (34) and (39), and T_f , which is used with regard to a time constant of a filter. It should be necessary to use a filter with a suitable time constant T_f to the disturbance $\Delta P_L(t)$, which is considered to be an input of the control system, to ensure its possible derivative when calculating the sliding control signal. Figure 3 shows the operating principle of the whole system. A step-load change of a 2% amplitude is embedded in the system.

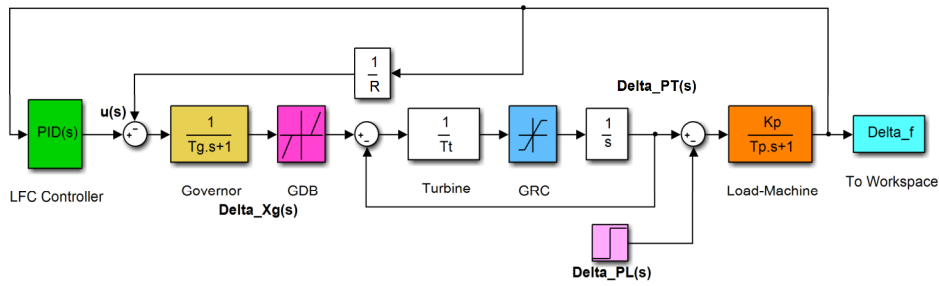

Fig. 1. A single-area power system considering GDB and GRC.

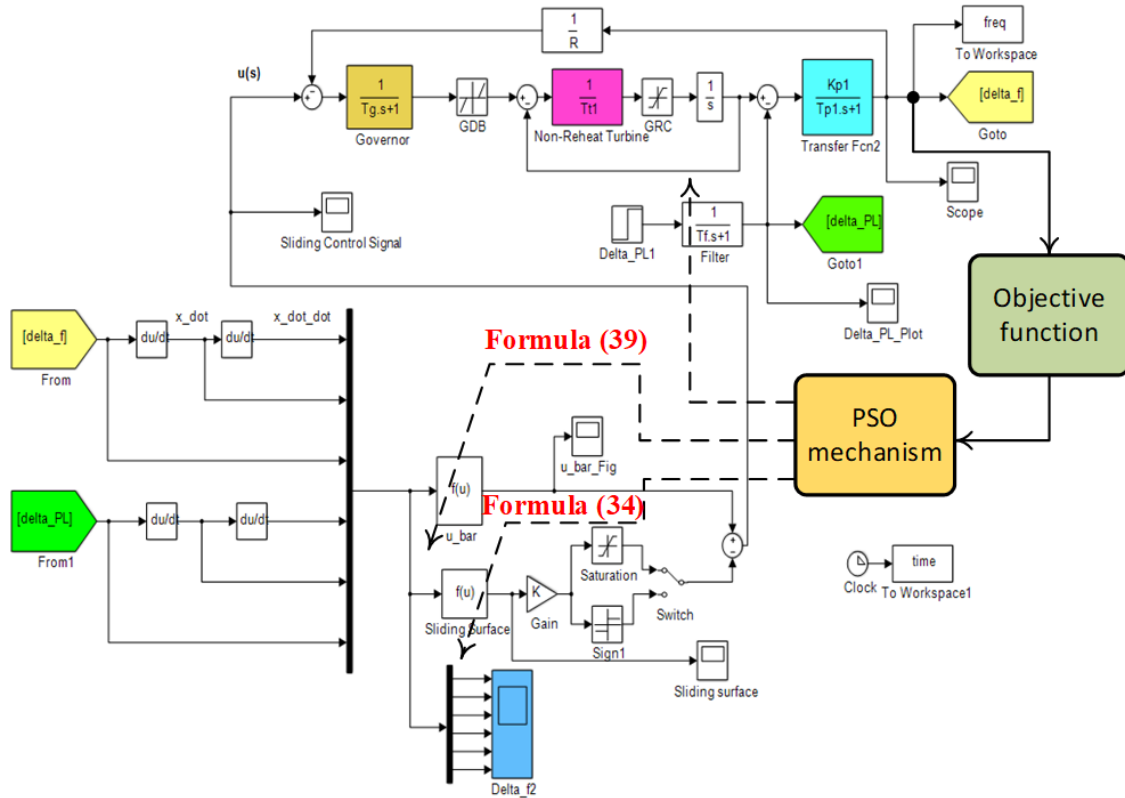

Fig. 2. Simulated model for applying robust *mSMC*-based LFC strategy

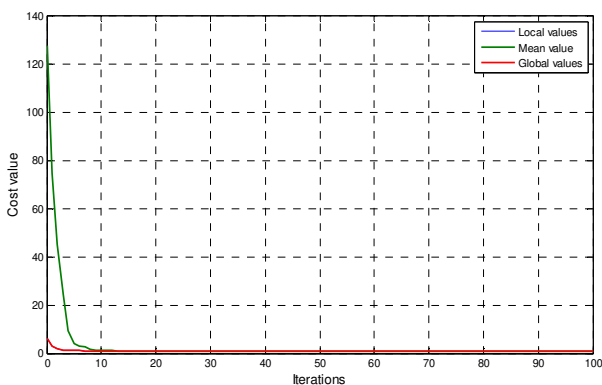

Fig. 3. Convergence results for the PSO algorithm applied to the *mSMC*.

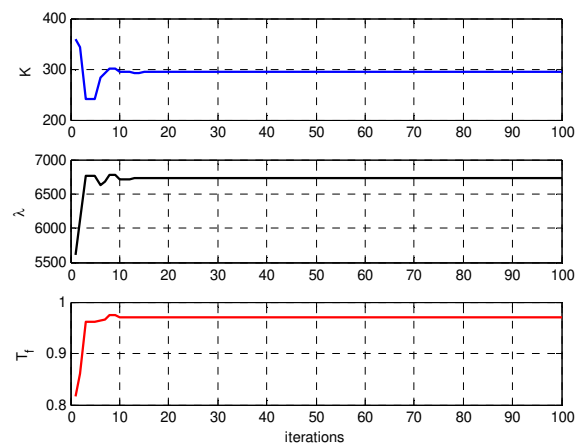

Fig. 4. The convergence of three parameters resulting from PSO.

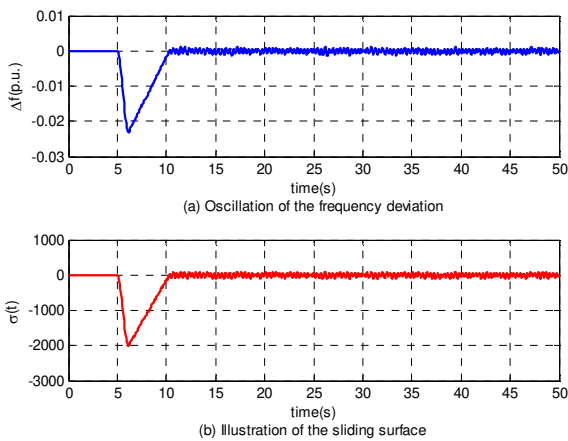

Fig. 5. Frequency deviation and sliding surface resulting of *mSMC*.

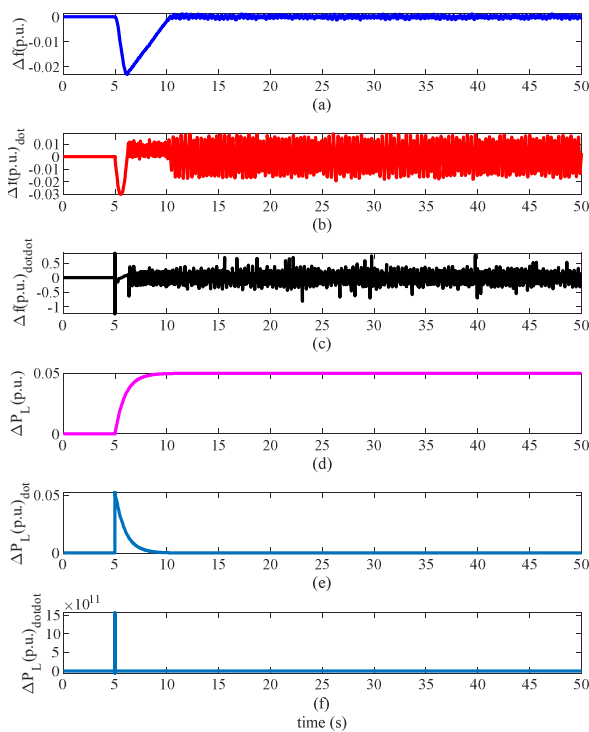

Fig. 6. Results for the proposed SMC-based LFC strategy

Figures 3-6 illustrate the obtained numerical results. Figure 3 shows the convergence of the PSO algorithm. After several iterations, it is clear that the global and local values are the same, hereby the three parameters converge, as shown in Figure 4. Figures 5 and 6 show the frequency deviation and load changes regarding their values, the first and second derivatives, the fluctuations in the system frequency, and the sliding mode surface.

Figure 7 shows the simulation results of frequency deviations in the case of using *mSMC*, PID [2], and PI-like fuzzy logic controllers (PI-FLC) [24]. Figure 8 describes the undershoots of oscillations regarding frequency changes for all three FLC controllers. These Figures show that the proposed

mSMC-based LFC can damp the dynamic deviation of frequency quickly against the presence of nonlinearities and disturbance. The PID-based LFC controller and the fuzzy logic one can also force the system frequency to zero, but obtain poor control performances such as higher undershoots and much longer settling times.

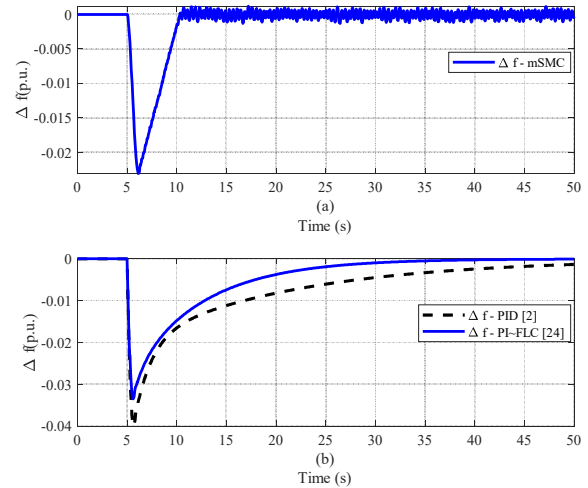

Fig. 7. Frequency deviations resulting from different LFC controllers

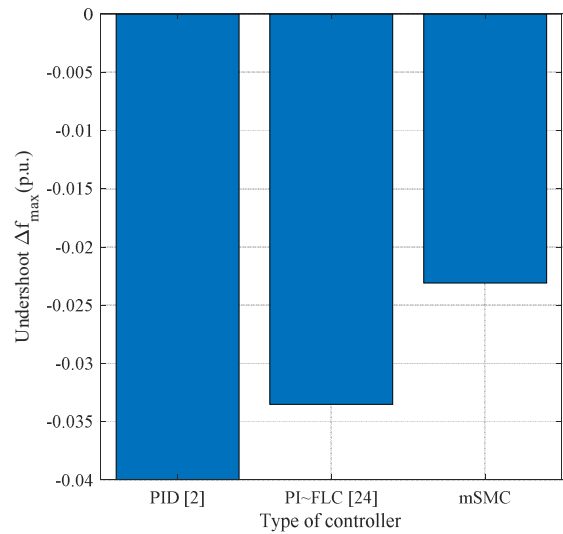

Fig. 8. Comparison of different LFC controllers regarding undershoots demonstrating the better performance of *mSMC*.

In this context, the *mSMC* strategy outperforms the other two counterparts. In conclusion, the robustness and effectiveness of the proposed *mSMC* control strategy were clearly demonstrated when dealing with the LFC problem considering nonlinearities.

VI. CONCLUSIONS

This paper presented a novel robust SMC-based LFC strategy to deal with the nonlinearities of an electric power system. The effect of nonlinearities (i.e. GDB and GRC) was

minimized successfully when the proposed control method was applied. The superiority of the proposed control strategy over the traditional PID regulator and the traditional fuzzy logic counterpart was also proved through several numerical simulations. The promising results show the feasibility of the proposed control strategy. Future work should focus on extending the power system to be more complicated and practical, e.g. having more generators and controllers. Furthermore, uncertain parameters should be considered to reach the real conditions of electric power grids.

REFERENCES

- [1] V. Vittal, J. D. McCalley, P. M. Anderson, and A. A. Fouad, *Power System Control and Stability*, 3rd ed. Hoboken, NJ, USA: Wiley-IEEE Press, 2019.
- [2] P. S. Kundur, *Power System Stability and Control*. New York, NY, USA: McGraw Hill, 1994.
- [3] H. Bevrani, M. Watanabe, and Y. Mitani, *Power System Monitoring and Control*. Hoboken, NJ, USA: Wiley, 2014.
- [4] H. B. Hiyama Takashi, *Intelligent Automatic Generation Control*. Boca Raton, FL, USA: CRC Press, 2017.
- [5] H. Bevrani, *Robust Power System Frequency Control*. Boston, MA, USA: Springer US, 2009.
- [6] W. Fan, Z. Hu, and V. Veerasamy, "PSO-Based Model Predictive Control for Load Frequency Regulation with Wind Turbines," *Energies*, vol. 15, no. 21, Jan. 2022, Art. no. 8219, <https://doi.org/10.3390/en15218219>.
- [7] D. V. Doan, K. Nguyen, and Q. V. Thai, "A Novel Fuzzy Logic Based Load Frequency Control for Multi-Area Interconnected Power Systems," *Engineering, Technology & Applied Science Research*, vol. 11, no. 4, pp. 7522–7529, Aug. 2021, <https://doi.org/10.48084/etasr.4320>.
- [8] H. K. Alaei, A. Yazdizadeh, and A. Aliabadi, "Nonlinear predictive controller design for load frequency control in power system using quasi Newton optimization approach," in *2013 IEEE International Conference on Control Applications (CCA)*, Hyderabad, India, Dec. 2013, pp. 679–684, <https://doi.org/10.1109/CCA.2013.6662828>.
- [9] A. Huddar and P. S. Kulkarni, "A Robust Method of Tuning the Feedback Gains of a Variable Structure Load Frequency Controller Using Genetic Algorithm Optimization," *Electric Power Components and Systems*, vol. 36, no. 12, pp. 1351–1368, Nov. 2008, <https://doi.org/10.1080/15325000802258380>.
- [10] T. Dao, Y. Wang, and N. Nguyen, "Applying metaheuristic optimization methods to design novel adaptive PI-type fuzzy logic controllers for load-frequency control in a large-scale power grid," *Turkish Journal of Electrical Engineering and Computer Sciences*, vol. 24, no. 6, pp. 4900–4914, Jan. 2016, <https://doi.org/10.3906/elk-1503-184>.
- [11] Z. Deng, C. Xu, Z. Huo, X. Han, and F. Xue, "Sliding Mode Based Load Frequency Control and Power Smoothing of Power Systems with Wind and BESS Penetration," *Machines*, vol. 10, no. 12, Dec. 2022, Art. no. 1225, <https://doi.org/10.3390/machines10121225>.
- [12] M. S. Shah, T. Mahmood, M. F. Ullah, M. Q. Manan, and A. U. Rehman, "Power Quality Improvement using Dynamic Voltage Restorer with Real Twisting Sliding Mode Control," *Engineering, Technology & Applied Science Research*, vol. 12, no. 2, pp. 8300–8305, Apr. 2022, <https://doi.org/10.48084/etasr.4734>.
- [13] S. Younsi and N. Hamrouni, "Control of Grid Connected Three-Phase Inverter for Hybrid Renewable Systems using Sliding Mode Controller," *International Journal of Advanced Computer Science and Applications*, vol. 9, no. 11, pp. 336–342, 2018, <https://doi.org/10.14569/IJACSA.2018.091146>.
- [14] A. Maafa, H. Mellah, K. Ghedamsi, and D. Aouzellag, "Improvement of Sliding Mode Control Strategy Founded on Cascaded Doubly Fed Induction Generator Powered by a Matrix Converter," *Engineering, Technology & Applied Science Research*, vol. 12, no. 5, pp. 9217–9223, Oct. 2022, <https://doi.org/10.48084/etasr.5166>.
- [15] X. Yu and M. Önder Efe, Eds., *Recent Advances in Sliding Modes: From Control to Intelligent Mechatronics*, vol. 24. Cham, Switzerland: Springer International Publishing, 2015.
- [16] G. Bartolini, L. Fridman, A. Pisano, and E. Usai, Eds., *Modern Sliding Mode Control Theory: New Perspectives and Applications*, vol. 375. Berlin, Heidelberg: Springer, 2008.
- [17] K. Vrdoljak, N. Perić, and I. Petrović, "Sliding mode based load-frequency control in power systems," *Electric Power Systems Research*, vol. 80, no. 5, pp. 514–527, May 2010, <https://doi.org/10.1016/j.epsr.2009.10.026>.
- [18] H. Sira-Ramírez, *Sliding Mode Control: The Delta-Sigma Modulation Approach*, 2015th edition. New York, NY, USA: Birkhäuser, 2015.
- [19] B. Bandyopadhyay, S. Janardhanan, and S. K. Spurgeon, Eds., *Advances in Sliding Mode Control: Concept, Theory and Implementation*, vol. 440. Berlin, Germany: Springer, 2013.
- [20] A. Rauh and L. Senkel, *Variable-Structure Approaches: Analysis, Simulation, Robust Control and Estimation of Uncertain Dynamic Processes*. Cham, Switzerland: Springer, 2016.
- [21] L. Fridman, A. Poznyak, and F. J. Bejarano, *Robust Output LQ Optimal Control via Integral Sliding Modes*. New York, NY, USA: Springer, 2014.
- [22] Y. Shtessel, C. Edwards, L. Fridman, and A. Levant, *Sliding Mode Control and Observation Shtessel 2014*. Basel, Switzerland: Birkhäuser, 2014.
- [23] J. Guo, "The Load Frequency Control by Adaptive High Order Sliding Mode Control Strategy," *IEEE Access*, vol. 10, pp. 25392–25399, 2022, <https://doi.org/10.1109/ACCESS.2022.3152259>.
- [24] N.-K. N. Nguyen Duy-Trung, "A Comparative Study on PI – and PD – Type Fuzzy Logic Control Strategies," *International Journal of Engineering Trends and Technology*, vol. 69, no. 7, pp. 101–108, 2021, <https://doi.org/10.14445/22315381/IJETT-V69I7P215>.
- [25] Y. Xiao, Y. Wang, and Y. Sun, "Reactive Power Optimal Control of a Wind Farm for Minimizing Collector System Losses," *Energies*, vol. 11, no. 11, Nov. 2018, Art. no. 3177, <https://doi.org/10.3390/en11113177>.