

Divided Wall Columns: Usefulness and Challenges

Hilke-Marie Lorenz^{a,*}, Daniel Staak^a, Thomas Grützner^b, Jens-Uwe Repke^{c,*}

^a Lonza Specialty Ingredients, Lonza AG, Visp, Switzerland

^b Ulm University, Institute of Chemical Engineering, Thermal Process Technology, Ulm Germany

^c Technical University of Berlin, Process Dynamics and Operations Group, Str. des 17. Juni 135, 10623 Berlin, Germany
 Jens-Uwe.Repke@TU-Berlin.de; hilke.lorenz@lonza.com

Distillation systems are responsible for the highest amount of energy consumption in the chemical industry. Therefore, in recent years, fully thermally coupled distillation sequences have become increasingly of interest. The realization of such an intensified system for the separation of a multicomponent feed into three fractions in one column shell with one or more dividing walls and in general with one reboiler and one condenser is called a dividing wall column (DWC). Since the first reported implementation of a DWC by BASF in 1985, the number of these columns has been significantly increased. The position of the divided wall is not limited to the middle of the column. Installation of the wall at either bottom or top of the column is possible. Additionally, concerning to the column design, various papers have been published analyzing the operability and controllability of DWCs. Nevertheless, the design and operation of a DWC still seems to be a domain of specialists. In this contribution, starting with the discussion of systematic design methods for DWCs and the generation of robust process control concepts, industrial examples will be presented. The presented examples, e.g. a multipurpose DWC and a DWC for extractive distillation, demonstrate, that a straightforward design and a flexible as well as robust control strategy for DWCs is possible. As a result, DWCs can be assumed to be “conventional” distillation systems today.

1. Introduction

Distillation systems are responsible for the highest amount of energy consumption in the chemical industry and therefore improving the performance of the distillative separations means at the same time, that the entire process can become more sustainable. During the last few decades, dividing wall columns (DWC) have moved more and more into the focus of research and development, because DWCs are a promising technology for creating sustainable, more energy and economically efficient processes. A DWC is in essence a fully thermally coupled distillation sequence with only one condenser and one reboiler regardless of the number of products. The entire sequence is packed into a single shell by means of one or more vertical partition walls (Dejanovic et al., 2011). The evolution of the DWC is visualized in Figure 1 in a very general manner. Of course, it is well established, that regarding the definition given above, DWCs nowadays are not limited to only a single reboiler and one condenser, e.g., looking at an extractive distillation process (Staak et al., 2017) carried out in a DWC (see Fig. 6). In Figure 1 it can be seen, that full heat integration of a column with a prefractionator leads to a Petyuk column and further integration of the prefractionator into a single shell leads to a DWC. In doing so, savings in capital expenditure, space, and energy of up to 30 to 50% are possible. It must be mentioned, that at the same time flexibility is decreasing with the physical integration: Only one column pressure is feasible and frequently it is stated that a more complex control strategy is required. Although, the Petyuk column configuration has been published in 1965, the first partitioning wall in column for cracked products was already described in a US Patent by Luster in 1933 (Luster, 1933). In the development of the DWC, a milestone certainly was the first industrial implementation of a DWC in 1985 by BASF SE in a packed column developed in cooperation with J. Montz GmbH (Kaibel et al., 2006). The invention of the so called non-welded DWCs in 1996 by Montz (Kaibel et al., 2006) led to a significant increase of the installation of DWCs in the process industry. Today, DWCs are an established technology and hundreds of columns are

in operation with column heights of up to 100m. A brief history of the development of DWCs is given in (Dejanovic et al., 2010).

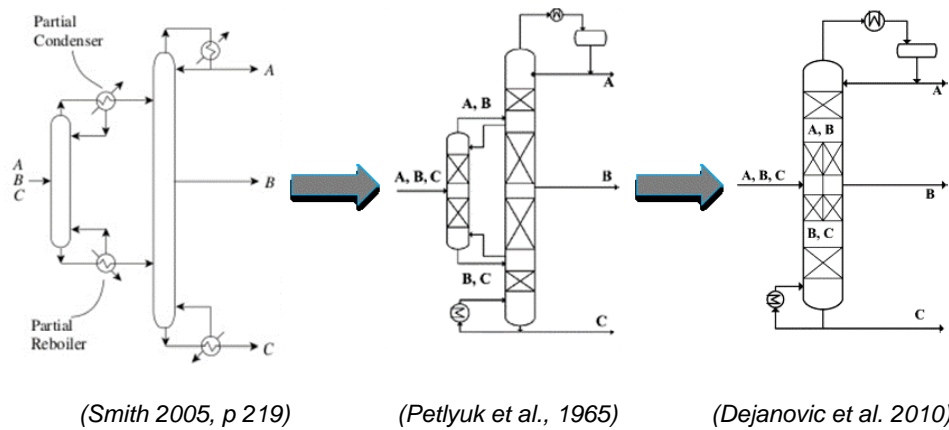

Figure 1: The “evolution” of dividing wall columns (DWC).

While DWCs seems to be a very promising technology, they are only an advisable solution whenever a high purity of a middle boiling product is desired (Schultz et al., 2002). In (Schultz et al., 2002) and (Asprion et al., 2010) some guidelines on the viability of DWCs are given: DWC are beneficial for an excess of middle boiling components (60 to 70 mol%) and approximately equal levels of high and low boiling compounds are present. Also, the relative volatilities of light-to-middle and middle-to-heavy boiling components should be similar. DWCs are for example inadvisable, whenever different operation pressures for the subsequent separations are required (in the case of heat integration, avoiding excessive temperature), cheap heating or cooling utilities at intermediate temperature levels are available, or very large columns are required (constructional constraints). Because of the rising numbers of DWCs in operation, with the increasing knowledge and experience, the design of DWCs (estimation of the separation performance) and the operation (not every time advanced control strategies are needed) DWCs become a standard option in the scope of process synthesis or revamping/optimization of existing separation processes. Therefore, the motivation of this contribution is to give a dense discussion of the published state of the art in comparison with a real industrial procedure concerning the design and simulation, certain selected aspects of construction, and the control and operation of DWCs. The discussion is done based on a number of industrially implemented examples.

2. Design and Simulation Aspects of DWCs

Considering a three-component mixture, which should be separated in a DWC with a middle section wall, there are in total 12 design variables available:

12 Design Variables of a (mid-section) DWC:

- Column pressure
- Number of stages in each of the 6 sections
(also implying the feed positions)
- Liquid distribution to partition between the two sides of the wall
(valve or time-based controller)
- Vapor distribution to partition between the two sides of the wall
(cross sectional area and internals – flow distributes to yield equal pressure loss)
- One specification per product stream
(e.g. reboiler duty + reflux ratio + amount of side draw)

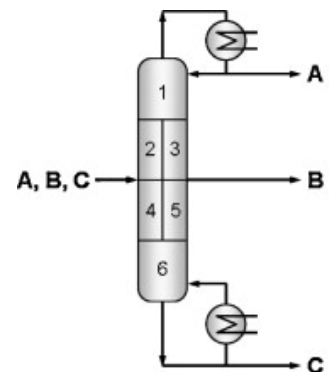

Figure taken from (Asprion et al., 2010)

Figure 2: Overall number of design variables for standard (mid-section) DWCs.

In open literature, different strategies for the approximation of the required numbers of trays in each column section (short cut) and also more detailed design methodologies (model based and also including

optimization) can be found. For example, (Kiss, 2013) recommends starting with common design rules for a conventional two column system. Based thereon the total numbers of stage for the DWC should lie at roughly 80% of the determined value. For placing the dividing wall in the middle of the column, 33 to 66% of the overall height is a good initial guess. Reboiler and condenser duties could be initially assumed at 70% of the two-column system. The initial vapor and liquid split for the internal wall regions should be set to 50%. After these first estimates, rigorous simulation is still necessary, e.g. the vapor and liquid need to analyze carefully. Often special attention must be given also for the pressure drop at each side of dividing wall. However, as of now no specialized model is available in commercial flowsheet packages. This is briefly considered below. In general, the design procedure of a DWC follows the conventional path given for standard distillation columns. Such a procedure was described and actively applied by (Grützner et al., 2016) (see Figure 3).

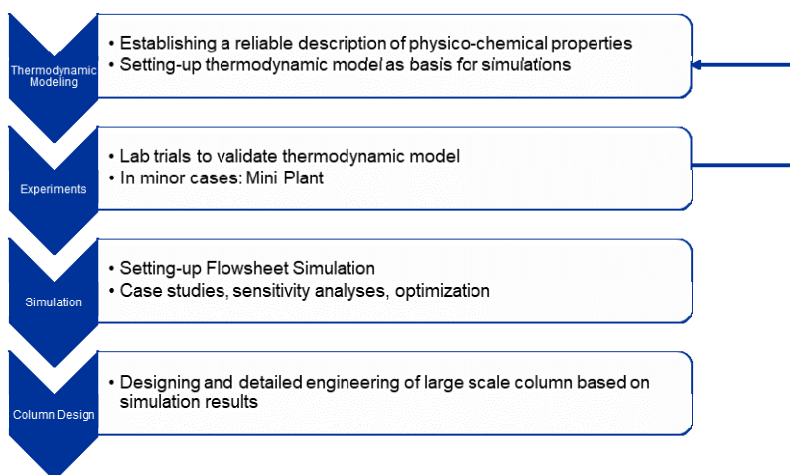

Figure 3: General design of a distillation column, also applicable for DWC design (taken from Grützner et al., 2016).

After estimation of the number of required stages, a rigorous simulation is carried out. Unfortunately for a long time, no DWC module has been available in the commercial flowsheet packages. Recently, ASPEN Plus offers a module like (Staaq et al. 2014). In general, users need to arrange their own model to realize the DWC. The arrangement, which best reflects actual situation, is the four-column sequence (see Figure 4).

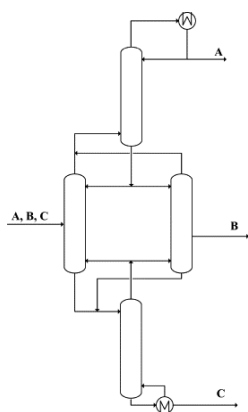

Figure taken from (Dejanovic et al., 2010)

Figure 4: Four-column arrangement for the simulation of DWCs in a flowsheet simulator.

Other sequences, such as the “liquid pump-arounds and vapour bypass” with one column or a column with a pre-fractionator like the Petlyuk arrangement, are also used. The four-column arrangement represents the real configuration in the best way, as it realizes the greatest flexibility regarding specifications for different column sections, vapour and liquid splits, and is most suitable for dynamic simulation. However, the four-column arrangement is also the most difficult to initialize. More initial estimates of interconnecting streams are required, and the solution is often characterized by the slowest convergence. To overcome the mentioned

drawbacks, in particular regarding the initialization procedure, (Staak et al., 2014) suggest as a first step to use a main column followed by a post-fractionator and to initialize the post-fractionator first. Afterwards, the two-column arrangement is solved, and the results are transcribed to the four-column configuration. The entire procedure is summarized in the Figure 5.

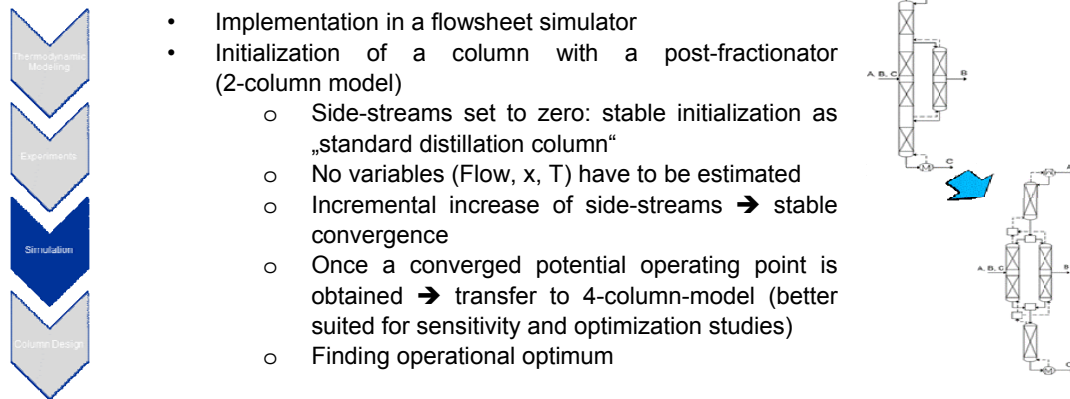

Figure 5: Initialization and solution procedure for simulation of a mid-section DWC in a commercial process simulator as given by (Staak et al., 2014).

Following the procedure presented in Fig. 3, the retrofit of existing columns and the merger into a DWC in a single shell will be briefly considered (see Fig. 6). The retrofit was done, to massively reduce the OPEX. In the final design, the lower part consists of trays and the upper part with a smaller diameter of packings. The system is designed as an extractive DWC column with an upper partition wall that features two condensers and for outlet streams (two at the top, one side and one bottom stream).

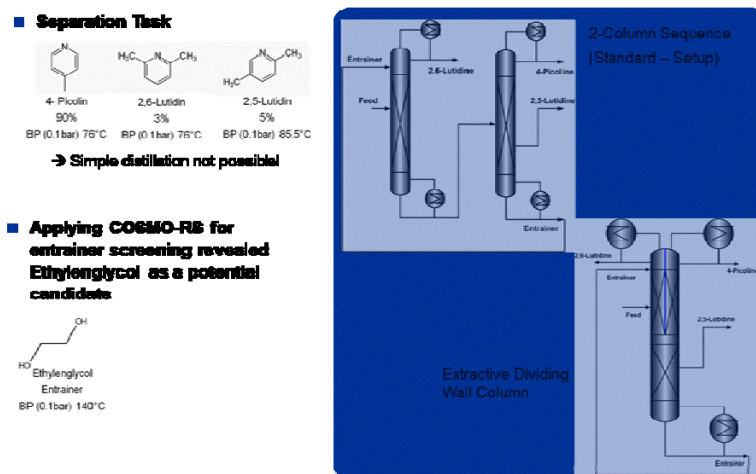

Figure 6: An extractive DWC for the separation of picolin from lutidin with ethylen glycol as entrainer.

3. Control and Operation Aspects of DWCs

Considering a three-component feed, which needs to be separated into three high quality products in a direct distillation sequence of two columns, changing the reboiler duty of the second column does not affect the product quality of the product of the first column. By contrast, in a DWC the reboiler duty directly influences the purity of all three products. Using the conventional side-columns, the degree of freedom for control is 6 (reboiler duty Q_B , cooling duty Q_C , top-, bottom-, and side-product flow rates). In a DWC column an additional variable, the liquid split ratio appears, i.e. the distribution of the liquid between both sides of the partitioning wall (see Figure 7). It should be noted, that the vapor split is a self-adjusting value, which is influenced by the physical design and the liquid load and normally cannot be actively manipulated during operation. In general, three manipulated variables are required for controlling the three product purities. This leaves the remaining three for level control, pressure control (if required), and for example for the minimization of operation costs.

Control of Dividing Wall Columns

Considering a three-component feed to be separated into three pure products:

- **3 to 4 main manipulated variables:**
 - reflux ratio
 - reboiler duty
 - side-stream flow
 - liquid split ratio (sometimes fixed)
- vapor split ratio is self-adjusting during operation
- 3 manipulated variables needed for 3 controlled product purities; 4th can be used to minimize operating costs
- much stronger interaction of manipulated and controlled variables in DWCs
- Simplest successful approach: classic PI-controller feedback control; drawback: some optimization potential has to be sacrificed to ensure stable operation

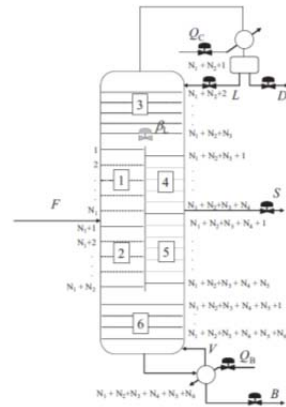
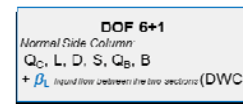

Figure taken from (Kiss & Bildea 2011)

Figure 7: Possible control layouts for a dividing wall column.

Given the system's nature, there is often a much stronger interaction of manipulated and controlled variables in DWCs compared to conventional systems. Still, in many cases using the simple classical PI controller for feedback arrangement is very successful. In (Staak et al., 2014), only standard PI controllers are implemented, and no APC is needed for the control of a DWC in a multi-purpose plant. The control structure is sketched in Figure 8 and top as well as side product purities are controlled using inferential temperature control by manipulating distillate and side draw flows. The third product (at the bottom) is regulated by the "overall mass balance" as seen in Figure 8.

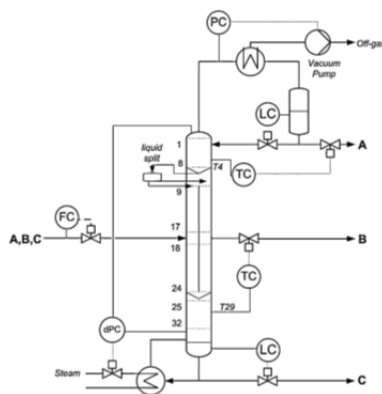

Figure 8: Control structure with only standard PI controllers for a DWC in a multi-purpose plant, taken from (Staak et al., 2014).

The extractive dividing wall column presented above is taken as a second example for the operation of a DWC with only common PI controllers. The resulting control structure is given in Figure 9 (left) and a comparison of the developed simulation model with temperature data are plotted alongside (Figure 9, right). A very stable operation can be achieved with this control structure. The feed flow rate is fixed and the entrainer flow rate is set to a fixed ratio to the feed stream. Sensitive temperature measurements are used for controlling the top and side products with standard PI controllers and a level control is implemented for the bottom stream. Again, no APC or higher control algorithm is required for the stable operation. Depending on the separation task and the configuration of the DWC basic PI controllers are sufficient for the realization of a stable operation. For active/real-time process optimization, more advanced control strategies would of course be required.

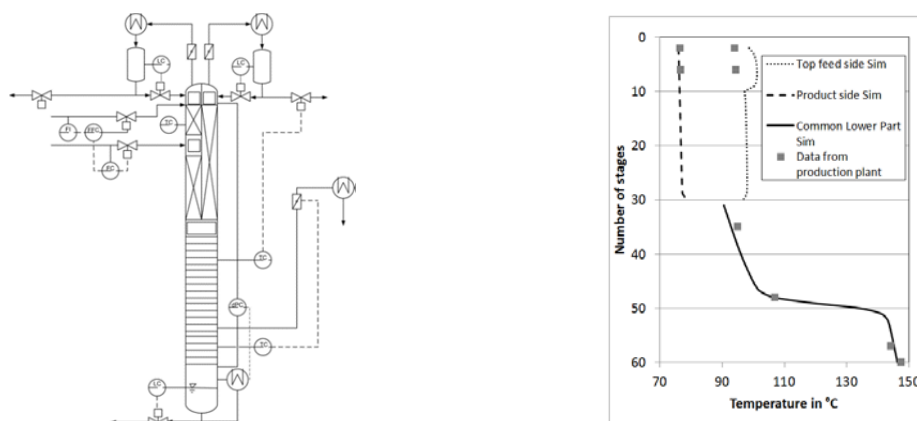

Figure 9: Extractive DWC with a PI-based control scheme (left) and resulting temperature profiles with comparison between plant data and simulations (right).

4. Conclusions

In this contribution, the state of the art of designing, simulating, and controlling DWCs is briefly discussed. Recent publications are reviewed in the light of industrially implemented examples: An extractive DWC with a partitioning wall at the top and DWC used in a multi-purpose plant are discussed. Some challenges are highlighted, but the discussion demonstrates that in many respects established methods, which have been developed for “conventional” two-columns systems, can be re-applied. DWCs are still an ongoing research topic, but in cooperation with experts, DWCs have recently become standard unit operations with rules for designing, simulating, and controlling them, which are close to generalization. Since DWCs is a quite new technology, there are still open questions depending different process and equipment issues. The authors will discuss some of these points of interest for both academic and industrial research.

References

- Asprion, N., Kaibel, G., 2010, Dividing wall columns. Fundamentals and recent advances, *Chemical Engineering and Processing: Process Intensification*, 49, 139–146.
- Dejanović, I., Matijašević, L., Halvorsen, I.J., Skogestad, S., Jansen, H., Kaibel, B., Olujić, Ž., 2011, Designing four-product dividing wall columns for separation of a multicomponent aromatics mixture, *Chemical Engineering Research and Design*, 89, 1155–1167.
- Dejanović, I., Matijašević, L., Olujić, Ž., 2010, Dividing wall column—A breakthrough towards sustainable distilling, *Chemical Engineering and Processing: Process Intensification*, 49, 559–580.
- Grützner, T., Schnider, C., Zollinger, D., Seyfang, B.C., Künzle, N., 2016, Reducing Time to Market by Innovative Development and Production Strategies, *Chemical Engineering & Technology*, 39, 1835–1844.
- Kaibel, B., Jansen, H., Zich, E., Olujić, Ž., 2006, Unfixed dividing wall technology for packed and tray distillation columns, *Distillation and Absorption Symposium Series*, 152, 252–266.
- Kiss, A.A., 2013, *Advanced distillation technologies: Design, control, and applications*, Wiley, Chichester, UK.
- Kiss, A.A., Bildea, C.S., 2011, A control perspective on process intensification in dividing-wall columns, *Chemical Engineering and Processing: Process Intensification*, 50, 281–292.
- Luster, E.W., 1933, Apparatus for fractionating cracked products, Patent no. US1915681A.
- Petlyuk, F.B., Platonv, V.M., Slavinskii, D.M., 1965, Thermodynamically Optimal Methods for Separating Multicomponent Mixtures, *International chemical engineering*, 5, 555–561.
- Schultz, M.A., Stewart, D.G., Harris, J.M., Rosenblum, S.P., Shakur, M.S., O'Brien, D.E., 2002, Reduce costs with dividing-wall columns, *Chemical Engineering Progress*, 98, 64–71.
- Smith, R., 2005, *Chemical process design and integration*, Wiley, Chichester, UK, Hoboken, USA.
- Staak, D., Grützner, T., Schwegler, B., Roederer, D., 2014, Dividing wall column for industrial multi-purpose use, *Chemical Engineering and Processing: Process Intensification*, 75, 48–57.
- Staak, D.; Grützner, T., 2017, Process integration by application of an extractive dividing-wall column: An industrial case study, *Chemical Engineering Research and Design*, 123, 120 - 129