



## Drag-Reducing Agent for Aqueous Liquid Flowing in Turbulent Mode through Pipelines

Ali M. Hameed\*

Ramzy S. Hamied\*\*

Zainab Y. Shnain\*\*\*

\*,\*\*\* Department of Chemical Engineering / University of Technology

\*\* Department of Petroleum Technology / University of Technology

\*E-mail: [alialjanabe@yahoo.com](mailto:alialjanabe@yahoo.com)

\*\*E-mail: [ramze\\_eng@yahoo.com](mailto:ramze_eng@yahoo.com)

\*\*\*E-mail: [za.yosif@yahoo.com](mailto:za.yosif@yahoo.com)

(Received 18 June 2013; accepted 15 April 2014)

### Abstract

In this study, mucilage was extracted from Malabar spinach and tested for drag-reducing properties in aqueous liquids flowing through pipelines. Friction produced by liquids flowing in turbulent mode through pipelines increase power consumption. Drag-reducing agents (DRA) such as polymers, suspended solids and surfactants are used to reduce power losses. There is a demand for natural, biodegradable DRA and mucilage is emerging as an attractive alternative to conventional DRAs. Literature review revealed that very little research has been done on the drag-reducing properties of this mucilage and there is an opportunity to explore the potential applications of mucilage from Malabar spinach. An experimental piping rig was used to study the DR properties of the mucilage on water under the effect of varying pipe dimensions and mucilage concentrations. It is shown that these additives can dramatically reduce friction drag provided that the flow is occurring under turbulent conditions. Experimental results also show that DR increases when the mucilage concentration increases.

**Keywords:** drag reduction, Turbulent flow, friction reduce, additives, pipeline, eddies

### 1. Introduction

Drag reduction (DR) is a significant area of interest in the transportation of fluids via pipelines, which is a crucial component of the chemical industry. Fluids flowing in turbulent mode commonly experience a drag, indicated by the pressure drop between two points. The drag phenomenon is unavoidable and pumping systems utilized to reduce pressure drop constitute 20% of the world's electricity demand (Chanson and Qiao., 2001).

Drag-reducing agents (DRA) have been formulated as a cheaper alternative to pumping systems, such as polymers, suspended solids, and surfactants. Mucilage, a compound found in plants, has been proven to have drag-reducing

properties, and it is an attractive alternative because it is easily procured and is biodegradable.

Drag reduction is the phenomenon of effectively reducing the friction factor of a flowing fluid by using a small amount of additives, named drag-reducing agents (DRA). Brostow, (2008) described DR as a phenomenon that occurs when an additive put into the fluid increases the average flow velocity. The mechanism of DR is still unknown. Different postulates to be placed forward to explain the DR mechanisms for different DRA.

The drag-reducing properties of suspended solids are not as extensively researched as polymers, but they are favored because they can be added (and removed) to ( and from) the liquid easily, and they are mechanically stable. There are two main types of suspended solids used; granular/spherical particles and fibers. When the

concentration of suspended solids increases the drag reduction also increases (Deverich, et al., 1985).

Surfactants reduce surface tension of a liquid and are usually organic compounds. Surfactant molecules aggregate at a critical concentration value, forming micelles (Truong, 2001). Surfactants display better drag-reducing properties at lower velocity gradients because the micelles disintegrate at higher velocity gradients.

Mucilage is a naturally-occurring polysaccharide in plants and in some microorganisms. Mucilage swells up to form a viscous, gel-like liquid when added to water. Examples of plants containing mucilage are cacti, flaxseeds, okra, fenugreek seeds, Aloe Vera and psyllium seeds. In 1990, Decho discovered that microorganisms living on "fluff", a layer of organic aggregates produced from bio deposits of oysters, secrete mucilage to stabilize fluff against water turbulence. The mucilage secreted reduces surface tension at the interface between fluff and water, creating less turbulent water at the interface.

Mucilage derived from okra has proven to reduce drag in water up to 58% (Rosli et.al, 2009). The same study also observed that the percentage drag reduction increases when the length-to-diameter ratio, L/D increases. Okra mucilage shows effective drag-reducing properties when water flows in turbulent mode through the pipeline.

Malabar spinach (Basella, 2009) is a perennial vine found in the tropics and is used in Chinese cuisine. The stem is very mucilaginous, and it is a very rich source of soluble fiber. The Malabar spinach is sometimes used to thicken soups due to the rich content of mucilage. The plant grows well in a variety of soils, with little dependence on soil fertility. The plant is easily cultivated and can be grown from either seeds or cuttings. In 2009, Stephens, concluded that even stems, which are too tough to eat can be put back into the soil and re-rooted.

Malabar spinach is easily available at local markets and at a very affordable price. The stems are typically uneaten and this does not diminish the demand for Malabar spinach as food. The price for 250g of Malabar spinach (leaves

included) is 0.42\$. The leaves contain little to no mucilage.

## 2. Experimental Procedure

### 2.1. Preparation of Mucilage

Malabar spinach was obtained from Malaysia. The stems are separated from the leaves and cleaned. The stems are then chopped into fine pieces until a semi-solid paste is formed. The paste is then mixed with water in the ratio of 100g of paste to 200mL of water. The mixture was allowed to stand in room temperature for approximately 24 hours, after which the mucilage is strained from the solids by filtering the mixture through a fine muslin cloth (diameter).

### 2.2. Operation of Piping Apparatus

The experiment was carried out in a piping apparatus as shown in Figure 1.

Tank 1 is filled with water until a volume of 420L is achieved. The mucilage concentrations tested are 0ppm, 100ppm, 300ppm, 500ppm, 700ppm and 1000ppm. The mucilage concentration in ppm, [M] is calculated using the equation (1):

$$[M] = \frac{\text{Weight of mucilage (g)}}{\text{Volume of water in tank (L)}} \times 10^6 \quad \dots(1)$$

The mucilage is added into Tank A while water is added to ensure a well-mixed solution. The solution is then allowed to circulate throughout the system. Water entering Tank B is recycled back to Tank B by the pump B. There are three testing pipes: pipe A with internal diameter 0.0381m, pipe B with internal diameter 0.0254m, and pipe C with internal diameter 0.0127m. For this study, only pipe B was utilized.

Flow rate of water circulating in the apparatus, Q, is measured using a non-invasive, ultrasonic portable flow meter. The flow meter used is Ultra flux Minisonic ® P which is clamped on the tested pipe. Pressure drop readings are taken using a barometer across four different pipe lengths; 0.5m, 1.0m, 1.5m and 2.0m. The readings are taken once Q is relatively constant.

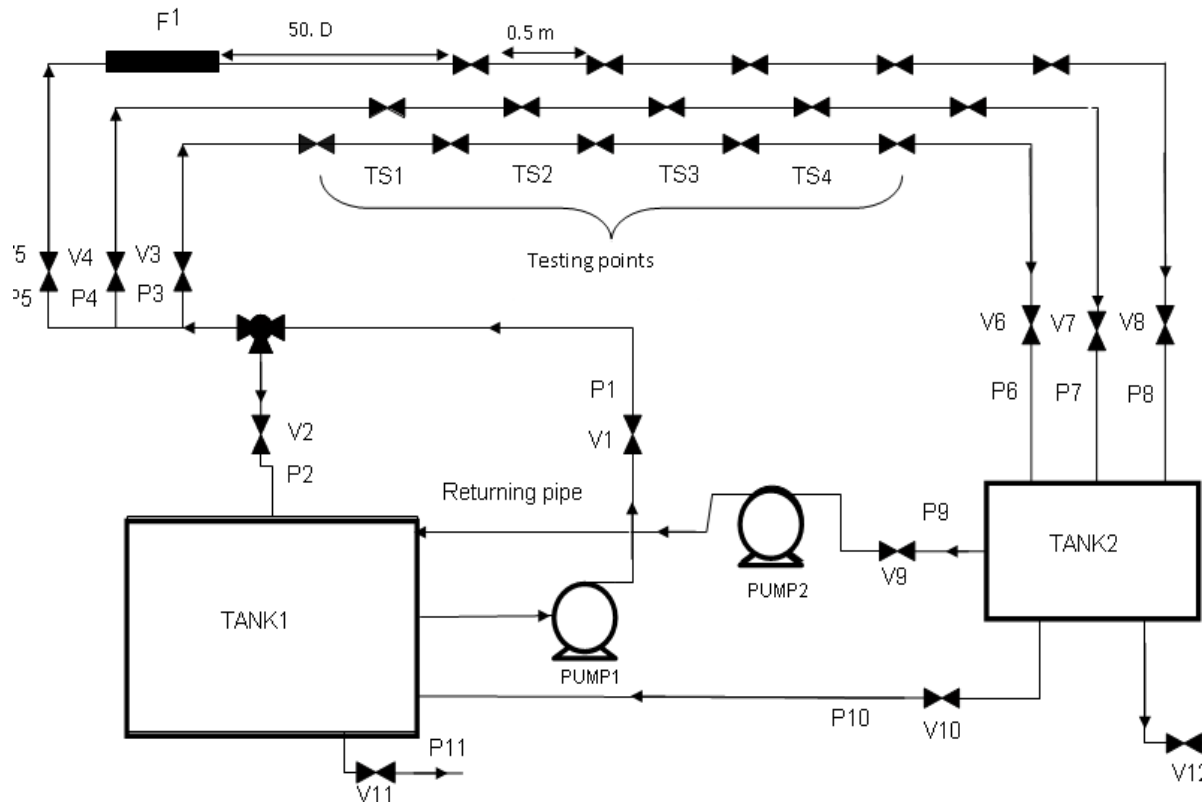

Fig. 1. Experimental rig.

### 2.3. Determination of Drag Reduction

At a fixed flow rate, the pressure drop values taken when mucilage concentration is 0ppm are denoted  $\Delta P_0$ . The pressure drop values taken at other concentrations and at the same flow rate are denoted  $\Delta P_i$ . Percent drag reduction, %DR, is calculated using the equation (2):

$$DR = \left( \frac{\Delta P_0 - \Delta P_i}{\Delta P_0} \right) \times 100\% \quad \dots(2)$$

We assumed temperature of the water to be 25°C. Reynolds numbers,  $Re$  is calculated using the equation (3):

$$Re = \frac{\rho v D}{\mu} \quad \dots(3)$$

where  $v = \frac{Q}{A}$  in m/s

Graphs are plotted to see the effect of Reynolds number, mucilage concentration and pipe length on drag reduction.

### 3. Results and Discussion

#### 3.1. Effect of Reynolds Number on DR

In Figures.(1 to 6) the percent drag reduction is plotted against Reynolds number for different pipe lengths in pipe B ( $D=0.00254m$ ). We observed that the %DR increases when  $Re$  increases but then decreases after a certain  $Re$  value. This is possibly due to increased shear stresses that eventually overwhelm the DR properties of the mucilage. The mucilage structure is said to undergo mechanical degradation and is unable to function as a DRA after that certain  $Re$  value from this figure, clearly we can see that an increasing of additive concentration can give great impact to the performance of percentage drag reduction.

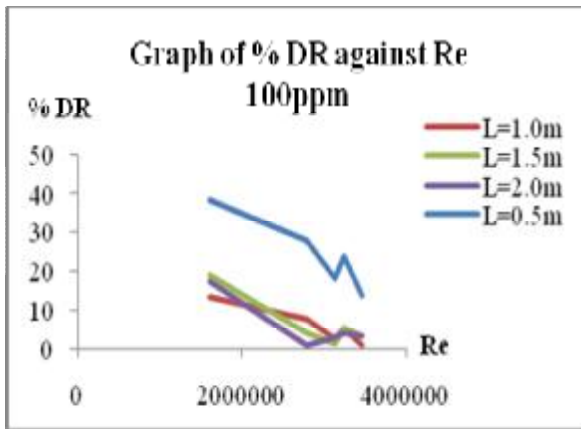

Fig. 2. Effect of Reynolds number on %DR at mucilage concentration of 100ppm.

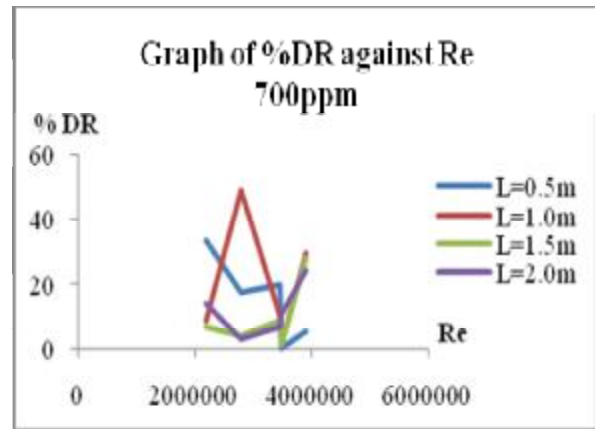

Fig. 5. Effect of Reynolds number on %DR at mucilage concentration of 700ppm.

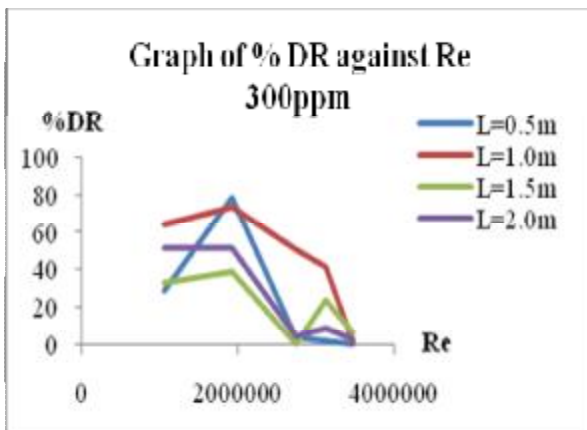

Fig. 3. Effect of Reynolds number on %DR at mucilage concentration of 300ppm.

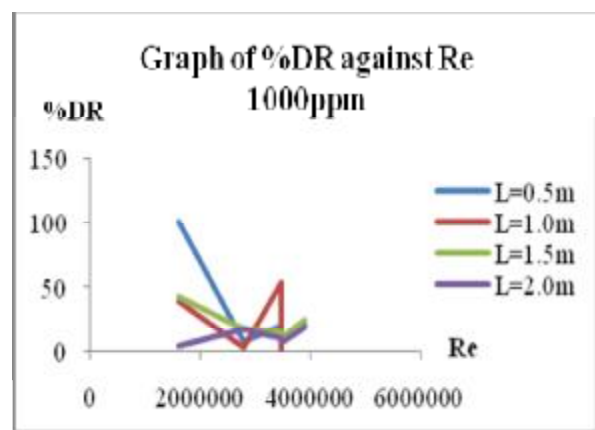

Fig. 6. Effect of Reynolds number on %DR at mucilage concentration of 1000ppm.

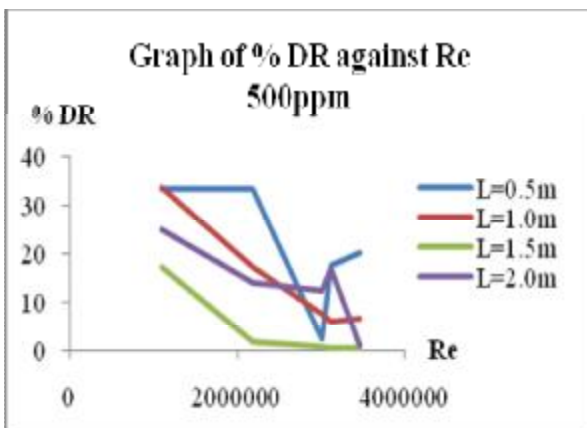

Fig. 4. Effect of Reynolds number on %DR at mucilage concentration of 500ppm.

### 3.2. Effect of Pipe Length on DR

In Figures (8 to 12) the percent drag reduction is plotted against pipe length for different Reynolds numbers. We observed that %DR increases with pipe length than either become constant or decrease. A possible reason for this behavior is the formation of laminar regions and turbulent slugs within the pipe, as described by Figure. 7 below:

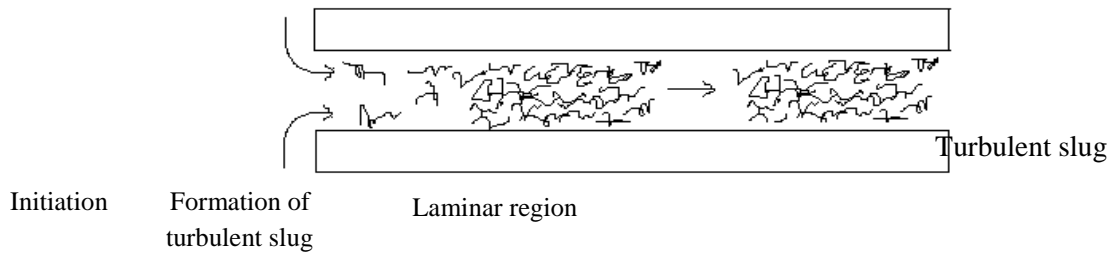

Fig. 7. Formation of laminar regions and turbulent slugs within the pipeline.

Davidson, (2006) described that initiation of turbulence begins at the pipe inlet. The turbulent patches grow and merge to establish fully developed turbulence. However, this turbulence is intermittent, being interspersed by quiescent, laminar regions. This description can explain the volatility in DR data across different pipe lengths as the turbulent regions within the pipe are interspersed with laminar regions, affecting the DR properties of the mucilage in these regions.

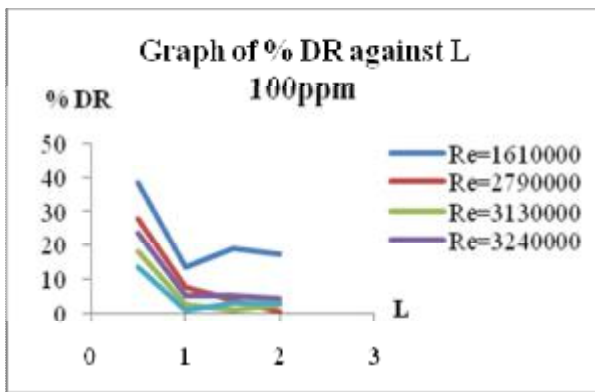

Fig. 8. Effect of pipe length on %DR at mucilage concentration of 100ppm.

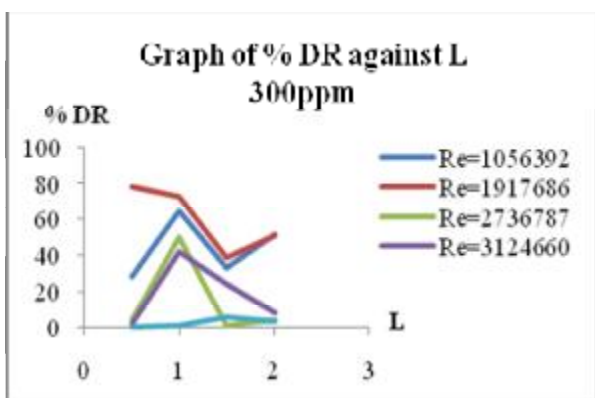

Fig. 9. Effect of pipe length on %DR at mucilage concentration of 300ppm.

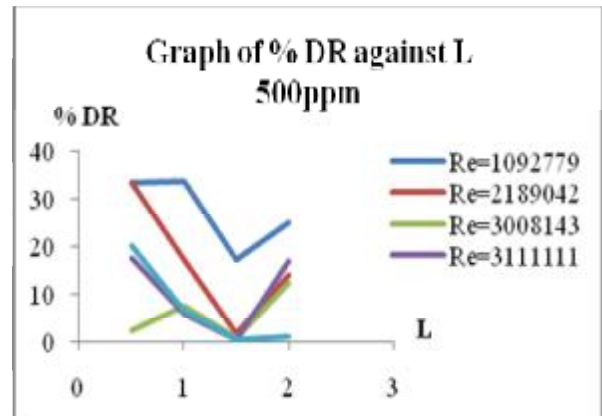

Fig. 10. Effect of pipe length on %DR at mucilage concentration of 500ppm.

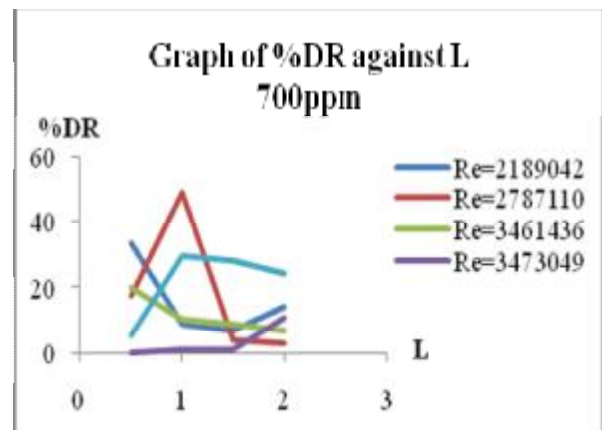

Fig. 11. Effect of pipe length on %DR at mucilage concentration of 700ppm.



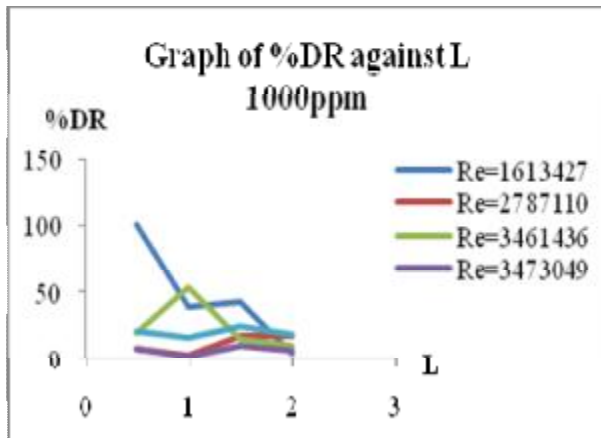

Fig. 12. Effect of pipe length on %DR at mucilage concentration of 1000ppm.

### 3.3. Effect of Mucilage Concentration on DR

Figure.13 represents the variation of %DR with increasing mucilage concentration. Generally, when mucilage concentration increases, %DR increases. This is because there are more mucilage components to interact with the fluid flow and to increase the occurrence of DR. It is observed that, by adding a low concentration of the additives, one can find a reduced pressure drop per unit length at the same flow conditions.

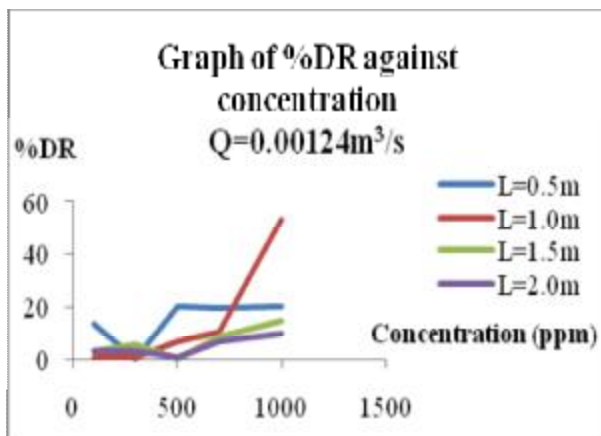

Fig. 13. Effect of mucilage concentration on %DR.

### 4. Conclusion

Mucilage from Malabar spinach can be used as a DRA for aqueous solutions. Experimental results show that DR increases when Reynolds number increases until a certain value where mechanical degradation occurs and the DR

properties of the mucilage are no longer effective. DR also increases when pipe length increases; however inconsistencies in experimental data may be due to the formation of alternating turbulent and laminar regions within the pipe. Experimental results also show that DR increases when the mucilage concentration increases.

### Notation

A	inside pipe area	$m^2$
D	internal pipe diameter	m
DR	drag reduction	
DRA	drag-reducing agents	
L	pipe length (length of testing section)	m
ppm	parts per million	
Q	water flow rate	$m^3/s$
Re	Reynolds number	
v	water velocity	m/s

### Greek letters

$\rho$	density of water at 25°C	$kg/m^3$
$\mu$	viscosity of water at 25°C	kg/m.s

### 5. References

- [1] Basella alba. (2009). Retrieved August 26, 2009 from [http://www.wikipedia.en/Basella\\_alba](http://www.wikipedia.en/Basella_alba).
- [2] Brostow, W. (2008), "Drag reduction in flow: Review of applications, mechanism and prediction", *Journal of Industrial and Engineering Chemistry*, 14, 409-416. doi:10.1016/j.jiec.2008.07.001
- [3] Chanson, H., & Qiao, G., "Drag Reduction in Hydraulics Flow", Brisbane: University of Queensland, (1994).
- [4] Davidson, P.A., "Turbulence: An Introduction for Scientists and Engineers", NY: Oxford University Press, (2006).
- [5] Decho, A. W., "Microbial exopolymer secretions in ocean environments: their role(s) in food webs and marine processes", *Oceanography and Marine Biology Annual Reviews*, 28, 78-153, (1990).
- [6] Deverich, I.V., Eroshenko, V.M. & Zaichik, L.I. (1985). Influence of particles on turbulent flow in channels. *Journal of Fluid Dynamics*, 20, 34-42. Retrieved August 24,

- 2009 from website  
<http://www.springerlink.com/content/x48hux265785117p/fulltext.pdf>
- [7] Graebel, W.P. "Advanced Fluid Mechanics", NY: Elsevier science and technology right Departmen oxford, Inc, (2007).
- [8] Rosli, M.Y., siti, N.K. & Hayder A.M.(2007), "Okra Mucilage as New Natural Pumping Power-Saver in Aqueous Media Flow in Pipelines", Paper presented at the 3rd International Conference on Chemical & Biochemical Engineering, Sabah. Retrieved August 27, (2009).
- [9] Langenheim, J.H., "Plant Resins: Chemistry, Evolution, Ecology & Ethnobotany", OR: Timber Press, (2003).
- [10] Stephens, M.J., Spinach, Malabar – Basella rubar L. Retrieved August 20, 2009 from <http://edis.ifas.ufl.edu/pdffiles/MV/MV13800.pdf>, (2009).
- [11] Truong, V.T., "Drag Reduction Technologies", Firshermans Bend Vic: DSTO Aeronautical and Maritime Research Laboratory, (2001).
- [12] Feng- Chen Li, Yasuo Kawaguchi, Bo Yu, Jin Jia Wei, Koichi Hishida, Experimental Study of Drag-Reduction Mechanism For A Dilute Surfactant Solution Flow, International Journal of Heat and Mass Transfer 51, 835-843, (2008).
- [13] Lixin Cheng, Dieter Mewes, Andrea Luke, "Boiling Phenomena With Surfactants And Polymeric Additives": A State-Of-The-Art Review, International Journal of Heat and Mass Transfer 50, 2744-2771, (2007).
- [14] D. Mowla and A. Naderi, "Experimental Study Of Drag Reduction By A Polymeric Additive In Slug Two-Phase Flow Of Crude Oil And Air In Horizontal Pipes", Chemical Engineering Science 61, 1549 – 1554, (2006).

## معامل الاعاقة للسوائل التي تتدفق في الوضع المضطرب خلال خطوط الانابيب

علي محمد حميد\* رمزي صيهود حميد\*\* زينب يوسف شنين\*\*\*

\*،\*\*،\*\*\* قسم الهندسة الكيمياءوية / الجامعة التكنولوجية  
 \*\*قسم تكنولوجيا النفط / الجامعة التكنولوجية  
 \*البريد الالكتروني: [alialjanabe@yahoo.com](mailto:alialjanabe@yahoo.com)  
 \*\*البريد الالكتروني: [ramze\\_eng@yahoo.com](mailto:ramze_eng@yahoo.com)  
 \*\*\* البريد الالكتروني: [za.yosif@yahoo.com](mailto:za.yosif@yahoo.com)

### الخلاصة

في هذه الدراسة تم استخلاص الصمغ من السبانخ واختبارها لغرض دراسة خواص تقليل الاعاقة للسوائل المائية التي تتدفق خلال خطوط الانابيب. الاحتكاك التي تنتجها السوائل المتدفقة في الوضع المضطرب من خلال خطوط الانابيب تؤدي الى زيادة في استهلاك الطاقة. ويستخدم معامل الاعاقة مثل البوليمرات، المواد الصلبة العالقة والسطحية للحد من خسائر الطاقة. هنالك طلب على المواد الطبيعية والمواد القابلة للتحلل والصمغية باعتبارها بديلا فعالا. كشفت مراجعة الادبيات السابقة بأنه يوجد ابحاث قليلة حول دراسة تقليل الاعاقة للصمغ وكذلك هنالك فرصة لامكانية استكشاف التطبيقات المحتملة للصمغ من السبانخ. تم استخدام انابيب الحفر التجريبية لدراسة خصائص الصمغ على المياه تحت تأثير ابعاد مختلفة للانابيب وكذلك تركيز الصمغ.